

Continuous ion-exchange membrane electro dialysis for drinking water production: Numerical analysis

Yoshinobu Tanaka

IEM Research, Ibaraki 300-1216, Japan

fwis1202@mb.infoweb.ne.jp

ABSTRACT

Computer simulation program of a continuous electro dialysis process is developed for saline water desalination. By inputting operating parameters into the program, the electro dialyzer is operated applying constant voltage to produce drinking water. Changing voltage step by step, the performance such as; ion and solution flux across a membrane pair; salt concentration in desalting and concentrating cells; current efficiency; water recovery; energy consumption; limiting current density are calculated. Electro dialysis conditions are discussed for producing drinking water meeting the WHO drinking water standard at under limiting current density stably. Standard deviation of solution velocity ratio between desalting cells functions as a safety factor in operating an electro dialyzer.

1. INTRODUCTION

Ion-exchange membranes are applied in electro dialysis to desalinate and concentrate salt solutions. The membranes are also applicable to separate ionic species in the solutions. Desalination is a fundamental technology in ion-exchange membrane electro dialysis, and its industrial applications extend in many fields at present. Electro dialysis processes are classified to a continuous, a batch and a feed-and-bleed process. Among these processes, the continuous process is the most fundamental one and it is applied to a large-scale electro dialysis. The performance of the continuous process is discussed from various points so far (Belfort 1970), (Avriel 1972), (Lee 2002), (Moon 2004), (Fidaleo 2005), (Sadradeh 2007), (Nikonenko 2008), (Brauns 2009).

In the previous investigation, the electro dialysis program of the continuous process was established for discussing the performance of saline water desalination processes (Tanaka 2009), (Tanaka 2010a). The program was applied to evaluate the performance of sea water concentrating plants (Tanaka 2010b). The influence of temperature on the performance of an

electrodialyzer was discussed (Tanaka 2011a). Data obtained by computation were compared to data observed by operating a practical-scale electrodialyzer for seawater concentration (Tanaka 2011b).

From the above investigations, the reasonability of the electro dialysis program is assumed to be generally demonstrated. The program consists of many steps describing many unit processes and it was established based on many fundamental principles and experiments. Precision of the program have been improved every time in the course of the program development. Consequently, the description of the program in the previous articles becomes partially insufficient, so the description becomes necessary to be supplemented. This article describes the supplemented program in which the principle of the continuous process is briefly explained. Further, an electrodialyzer is operated by applying constant voltage and by supplying 1000 mg/l and 25 °C raw saline water. Changing voltage applied step by step, the performance of the electrodialyzer such as; ion and solution flux across a membrane pair; salt concentration in desalting and concentrating cells; current efficiency; water recovery; energy consumption; limiting current density are computed. Electrodialyzer operating conditions are discussed for producing drinking water meeting the WHO drinking water standard at under limiting current density.

2. CONTINUOUS ELECTRODIALYSIS PROCESS

An electrodialyzer is operated with a constant electric current I as illustrated in Fig. 1. A salt solution (raw salt solution, concentration: C'_{in}) is supplied to the inlets of desalting cells (De) at average linear velocity of u'_{in} . For preventing scale formation in concentrating cells, a part of a raw salt solution is supplied also to the inlets of concentrating cells (Con) at the average linear velocity of u''_{in} . Ions and solutions transfer from desalting cells to concentrating cells across an ion-exchange membrane pair and their flux is defined by J_S and J_V respectively. In desalting (concentrating) cells, salt concentration is decreased (increased) from C'_{in} ($C''_{in} = C'_{in}$) under applied average current density I/S (I ; electric current, S ; membrane area) and reaches average salt concentration C'_{out} (C''_{out}) at the outlets of desalting (concentrating) cells. Salt concentration change in desalting cells causes current density change along the flow-pass from i_{in} at the inlets to i_{out} at the outlets. The current density becomes i at x distant from the inlets of desalting cells. I/S , J_S , J_V , C'_p , C''_p , u'_p and u''_p are altogether the values at $x = pl$ distant from the inlets of desalting and concentrating cells. V_{in} , V_{out} and V_p are voltage difference between electrodes respectively at the inlets ($x = 0$), the outlets ($x = l$) and $x = pl$ of desalting cells ($V_{in} = V_p = V_{out}$).

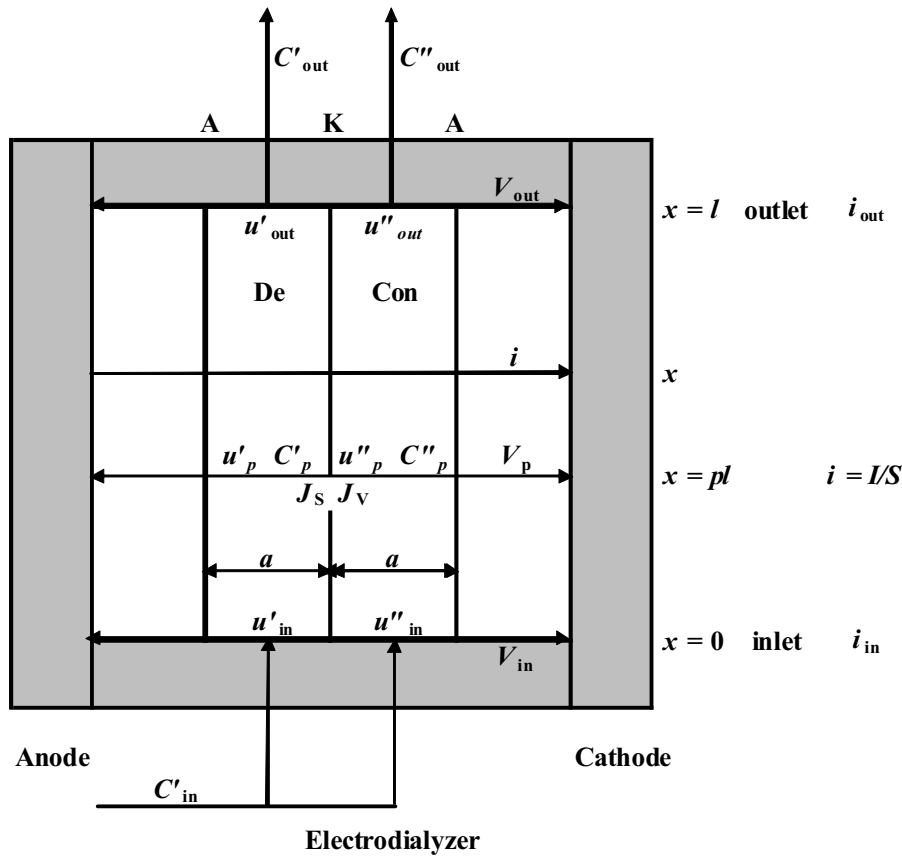

De: Desalting cell, **Con:** Concentrating cell
K: Cation-exchange membrane, **A:** Anion-exchange membrane
 J_S, J_V : Fluxes of ions and solutions across membrane pairs at $x = pl$
 C'_p, C''_p : Electrolyte concentration in desalting and concentrating cells at $x = l$
 u'_p, u''_p : Linear velocity in desalting cells and concentrating cells at $x = pl$

Fig. 1. Continuous process

3. ELECTRODIALYSIS PROGRAM

Main equations describing the phenomena in the continuous process are enumerated with brief explanation.

3.1. Overall mass transport equation

Flux of ions J_S and a solution J_V across an ion-exchange membrane pair at $x = pl$ are expressed by the following overall mass transport equation (Tanaka 2006).

$$J_S = \lambda (I/S) - \mu (C''_p - C'_p) = \eta (I/S)/F \quad (1)$$

$$J_V = \phi (I/S) + \rho (C''_p - C'_p) \quad (2)$$

Membrane pair characteristics λ , μ , ϕ and $2r_{alter} = r_K + r_A$ are expressed by the functions of ρ :

$$\lambda = 9.208 \times 10^{-6} + 1.914 \times 10^{-5} \rho \quad (3)$$

$$\mu = 2.005 \times 10^{-4} \rho \quad (4)$$

$$\phi = 3.768 \times 10^{-3} \rho^{0.2} - 1.019 \times 10^{-2} \rho \quad (5)$$

$$2r_{alter} = r_{alter,K} + r_{alter,A} = 1.2323 \rho^{-(1/3)} \quad (6)$$

ρ is expressed by the function of temperature T (Tanaka 2011a):

$$\rho = 3.421 \times 10^{-3} + 3.333 \times 10^{-4} T \quad (7)$$

3.2. Salt concentration and linear velocity in desalting cells

The following equations are introduced.

$$u'_{out} = Q'_{out}/ab = (Q'_{in} - blJ_V)/ab \quad (8)$$

$$u'_p = u'_{in} - p(u'_{in} - u'_{out}) = u'_{in} - p(q/ab) \quad (9)$$

$$C'_{out} = C'_{in} - \left(\frac{\eta l}{aF} \right) \left(\frac{1}{u'_p} \right) \left(\frac{I}{S} \right) \quad (10)$$

Frequencies Y_j of the linear velocity ratio ξ_j in desalting cell group j is defined as;

$$\xi_j = \frac{u'_j - \bar{u}'}{\bar{u}'} \quad (11)$$

u'_j : linear velocity in the desalting cells in group j , \bar{u}' : average linear velocity in desalting cells.

Frequencies Y_j of ξ in group j ; ξ_j is expressed by the normal distribution (standard deviation: σ) (Tanaka 2000), (Tanaka 2005). Many desalting cells are integrated in a stack in an electro dialyzer. ξ_j is divided among $j = 0 - n$ according to Eq. (12).

$$\xi_j = -3\sigma \left(1 - \frac{j}{n/2} \right), \quad j = 0 - n \quad (12)$$

Linear velocity at $x = pl$ distant from the inlets of j^{th} desalting cells is

$$u'_{pj} = u'_p (\xi_j + 1) \quad (13)$$

Accordingly

$$C'_{out,j} = C'_{in,j} - \left(\frac{\eta l}{aF} \right) \frac{1}{u'_{pj} (\xi_j + 1)} \left(\frac{I}{S} \right) \quad (14)$$

Salt concentration at $x = pl$ is:

$$C'_p = \frac{1}{N} \sum_{j=0}^n Y_j C'_{p,j} \quad (15)$$

$$C'_{p,j} = C'_{in} - \left(\frac{\eta l}{aF} \right) \left\{ \frac{1}{u'_{p/2} (\xi_j + 1)} \right\} \left\{ a_1 p + \left(\frac{a_2}{2} \right) p^2 + \left(\frac{a_3}{3} \right) p^3 \right\} \quad (16)$$

3.3. Salt concentration and linear velocity in concentrating cells

Saline water supplied to desalting cells is also supplied to concentrating cells.

$$C''_{out} = \frac{\sqrt{M^2 + 4LN} - M}{2L} \quad (17)$$

$$C''_p = C''_{in} + p(C''_{out} - C'_{in}) \quad (18)$$

$$u''_{out} = \frac{1}{2} \left(\sqrt{M^2 + 4LN} + M \right) \quad (19)$$

$$u''_p = u''_{in} + p(u''_{out} - u''_{in}) \quad (20)$$

in which

$$L = \frac{l}{a} \rho p \quad (21)$$

$$M = \frac{l}{a} \left[\phi \left(\frac{I}{S} \right) - \rho \{ C'_p - (1-p) C'_{in} \} \right] + u''_{in} \quad (22)$$

$$N = C''_{in} u''_{in} + \frac{l}{a} \left\{ \lambda \left(\frac{I}{S} \right) - \mu (C''_p - C'_p) \right\} \quad (23)$$

3.4. Electric resistance of an ion-exchange membrane pair and solutions in desalting and concentrating cells

Direct current electric resistance of an ion exchange membrane r_{mem} is calculated using the following equations (Tanaka 2003).

$$\log \left(\frac{r_{dire}^*}{r_{alter}} \right) = 0.3380 + 0.6386 \kappa' + 0.2961 (\log \kappa')^2 \quad (24)$$

$$\frac{r_{dire}}{r_{dire}^*} = 1.000 - 0.1359 \left(\frac{\kappa''}{\kappa'} \right) \quad (25)$$

$$r_{memb} = \left(\frac{r_{dire}^*}{r_{alter}} \right) \times \left(\frac{r_{dire}}{r_{dire}^*} \right) \times 2r_{alter} = 2r_{dire} \quad (26)$$

r_{alter} ; alternating current electric resistance of a membrane.

r_{dire}^* ; direct current electric resistance of a membrane measured in a diluate/diluate solution system.

r_{dire} ; direct current electric resistance of a membrane measured in a diluate/concentrate solution system.

Electric resistance of a desalting cell r' and of a concentrating cell r'' in an electro dialyzer are;

$$r' = \frac{a}{(1-\varepsilon)\kappa'} \quad (27)$$

$$r'' = \frac{a}{(1-\varepsilon)\kappa''} \quad (28)$$

ε is the volume ratio of a diagonal net spacer defined by;

$$\varepsilon = \frac{\pi a}{8\chi \sin \theta} \quad (29)$$

χ ; distance between spacer rods. θ ; crossing angle of the rods.

3.5. Current density distribution

Current density distribution is assumed to be approximated by the following quadratic equation expressed at x/l distant from the inlet of a desalting cell (Tanaka 2000).

$$i = a_1 + a_2 \left(\frac{x}{l} \right) + a_3 \left(\frac{x}{l} \right)^2 \quad (30)$$

To determine a_1 , a_2 and a_3 in Eq. (30), the following three-simultaneous equations are set up taking account of voltage difference between electrodes.

$$V_{in} = V_{out} \quad (31)$$

$$V_{in} = V_p \quad (32)$$

$$\zeta_{inout} = \zeta_{inp} \quad (33)$$

ζ_{inout} is introduced from Eq. (31) and expressed by Eq. (34), which is equals to ζ_{out} (outlet electric current non-uniformity coefficient).

$$\zeta_{inout} = \frac{\alpha_1 + \alpha_2 p + \alpha_3 p^2}{\beta_1 + \beta_2 p + \beta_3 p^2} = \zeta_{out} = \frac{i_{out}}{I/S} \quad (34)$$

ζ_{inp} is introduced from Eq. (32) and expressed by Eq. (35), which is also equals to ζ_{out} .

$$\zeta_{inp} = \frac{\gamma_1 + \gamma_2 p + \gamma_3 p^2}{(2p - 3p^2)(I/S)} = \zeta_{out} \quad (35)$$

We determine $a_1, a_2, a_3, \zeta_{in}$ (inlet electric current non-uniformity coefficient), ζ_{out}, i_{in} and i_{out} defined in the following equations.

$$\zeta_{in} = \frac{i_{in}}{I/S} = \frac{a_1}{I/S} \quad (36)$$

$$\zeta_{out} = \frac{i_{out}}{I/S} = \frac{a_1 + a_2 + a_3}{I/S} \quad (37)$$

3.6. Cell voltage, energy consumption, water recovery, desalting ratio

Ohmic voltage and membrane voltage at the inlet of the desalting cell ($V_{\Omega,in}$ and $V_{memb,in}$) and those at the outlet of the desalting cell ($V_{\Omega,out}$ and $V_{memb,out}$) are:

$$V_{\Omega,in} = (r'_{in} + r_{memb,in} + r''_{in}) i_{in} \quad (38)$$

$$V_{memb,in} = 2(t_K + t_A - 1) \times \left(\frac{RT}{F} \right) \ln \frac{\gamma''_{in} C''_{in}}{\gamma'_{in} C'_{in}} \quad (39)$$

$$V_{\Omega,out} = \left(\sum_{j=0}^n Y_j r'_{out,j} + \sum_{j=0}^n Y_j r_{memb,out,j} + r''_{out} N \right) \times i_{out} \times \left(\frac{1}{N} \right) \quad (40)$$

$$V_{memb,out} = 2(t_K + t_A - 1) \left(\frac{RT}{F} \right) \sum_{j=0}^n \ln \frac{\gamma''_{out,j} C''_{out,j}}{\gamma'_{out,j} C'_{out,j}} \times \left(\frac{1}{N} \right) \quad (41)$$

Cell voltage V_{cell} is introduced from Eqs. (38) – (41) as:

$$V_{cell} \text{ (V/pair)} = V_{\Omega, in} + V_{memb, in} = V_{\Omega, out} + V_{memb, out} \quad (42)$$

Energy consumption E is expressed by the following equation.

$$E \text{ (kWh / m}^3\text{)} = \frac{V_{cell} I}{Q'_{out}} \times 3600 \times 10^3 \quad (43)$$

Q'_{out} is the solution volume; output of the desalted solution.

Water recovery Re is:

$$Re = \frac{Q'_{out}}{Q'_{in} + Q''_{in}} \quad (44)$$

Desalting ratio α is:

$$\alpha = \left(1 - \frac{C'_{out}}{C'_{in}} \right) \quad (45)$$

3.7. Limiting current density

Limiting current density of a cation-exchange membrane is less than that of an anion-exchange membrane, because the mobility of counter ions in a solution for a cation-exchange membrane is less than that for an anion-exchange membrane. So the limiting current density of an ion-exchange membrane integrated in an electro dialyzer i_{lim} is given by the following empirical equation established for a cation-exchange membrane (Tanaka 2005).

$$i_{lim} = (m_1 + m_2 u'_{out}) C'^{m_1 + n_2 u'_{out}}_{out} \quad (46)$$

$$m_1 = 83.50, m_2 = 24.00, n_1 = 0.7846, n_2 = 8.612 \times 10^{-3}$$

When current density reaches the limit of a cation-exchange membrane i_{lim} at the outlet of a desalting cell in which linear velocity becomes the least among u'_{out} : $u'_{out}^{\#}$, the average current

density applied to an electro dialyzer is defined as its limiting current density $(I/S)_{\text{lim}}$ which is expressed by Eq. (47) introduced from Eqs. (37) and (46) putting $u'_{in}{}^{\#} = u'_{out}{}^{\#}$.

$$\left(\frac{I}{S}\right)_{\text{lim}} = \frac{i_{\text{lim}}}{\zeta_{out}} = \frac{m_1 + m_2 u'_{in}{}^{\#}}{\zeta_{out}} (C'_{out}{}^{\#})^{n_1 + n_2 u'_{in}{}^{\#}} \quad (47)$$

in which $C'_{out}{}^{\#}$ is C'_{out} at $u' = u'_{in}{}^{\#}$ which is given by;

$$u'_{in}{}^{\#} = u'_{in}(1 - 3\sigma) \quad (48)$$

The relationship between $(I/S)_{\text{lim}}$ and $C'_{out}{}^{\#}$ is also introduced as follows

$$\left(\frac{I}{S}\right)_{\text{lim}} = \left(\frac{a}{\lambda l}\right) u'_{in}{}^{\#} (C'_{in} - C'_{out}{}^{\#}) \quad (49)$$

Putting Eq. (47) = Eq. (49):

$$Z_1 = \frac{(C'_{out}{}^{\#})^{n_1 + n_2 u'_{in}{}^{\#}}}{C'_{in} - C'_{out}{}^{\#}} \quad (50)$$

$$Z_2 = \left(\frac{a\zeta_{out}}{\lambda l}\right) \left(\frac{u'_{in}{}^{\#}}{m_1 + m_2 u'_{in}{}^{\#}}\right) \quad (51)$$

$$Z_1 = Z_2 \quad (52)$$

Limiting current density of an electro dialyzer $(I/S)_{\text{lim}}$ is computed with trial and error calculation by substituting control key $C'_{out}{}^{\#*}$ for $C'_{out}{}^{\#}$ in Eq. (50) to realize $Z_1 = Z_2$ (Eq. (52)) for determining $C'_{out}{}^{\#}$. $(I/S)_{\text{lim}}$ is calculated by substituting $C'_{out}{}^{\#}$ into Eq. (47).

4. DRINKING WATER PRODUCTION

4.1. Operating conditions

The computation is carried out according to the electro dialysis program (Fig. 2) by inputting the following parameters into the programs keeping cell voltage V_{cell} constant.

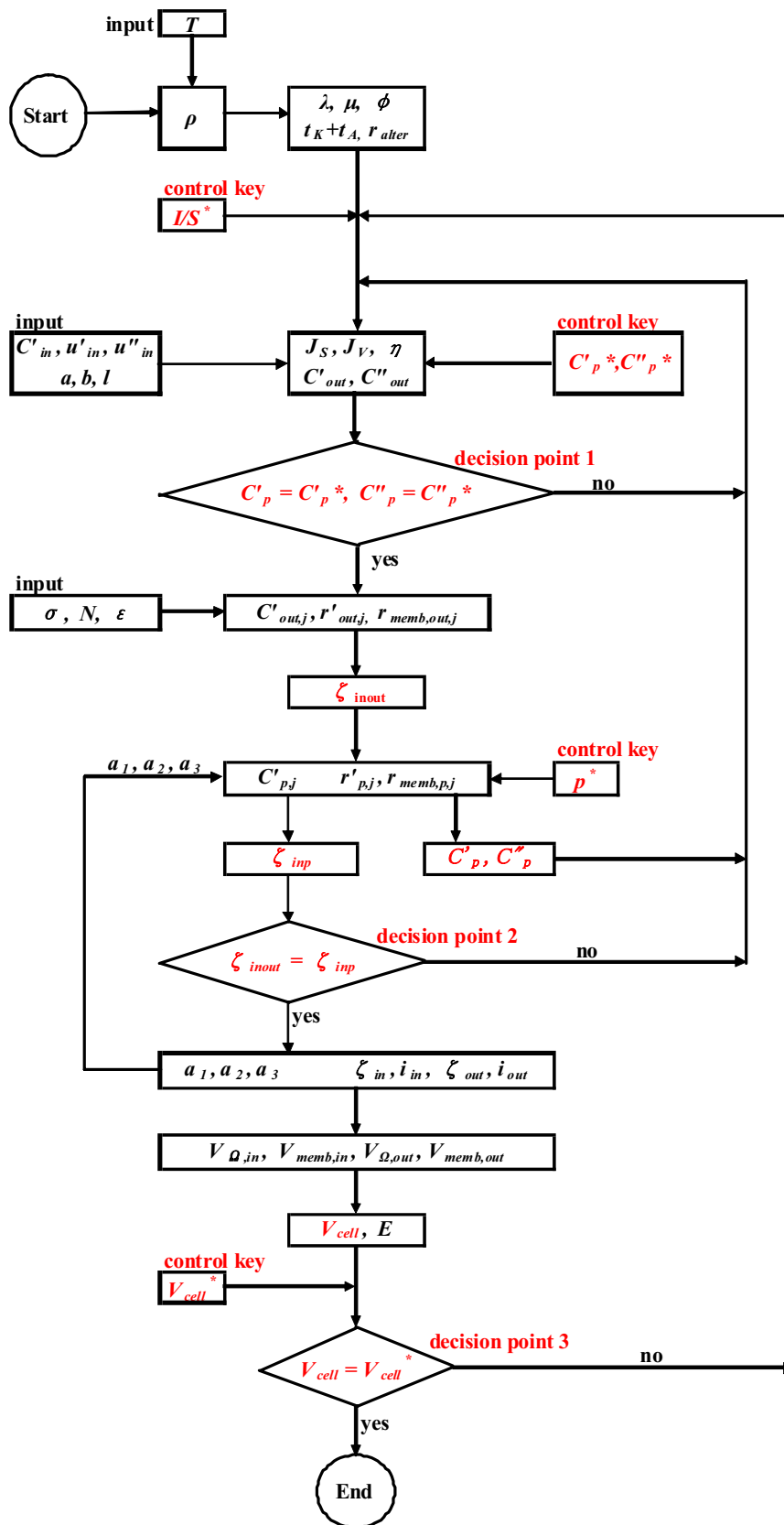

Fig. 2. Electrodesialysis program

Flow-pass thickness of a desalting and a concentrating cell $a = 0.05$ cm

Flow-pass width of a desalting and a concentrating cell $b = 100$ cm

Flow-pass length of a desalting and a concentrating cell $l = 100$ cm

Solution temperature $T = 25^\circ\text{C}$

Salt concentration at the inlets of desalting cells and concentrating cells $C'_{in} = C''_{in} = 1000$ mg/l

Linear velocity at the inlets of desalting cells $u'_{in} = 10$ cm/s

Linear velocity at the inlets of concentrating cells $u''_{in} = 1$ cm/s

Standard deviation of the normal distribution of solution velocity ratio $\sigma = 0, 0.05, 0.1, 0.15$

In decision point 1 in Fig.2, trial-and-error calculations are carried out to realize $C'_p = C'^*_p$ (control key) and $C''_p = C''^*_p$ (control key). In decision point 2, the calculations go on to realize $\zeta_{inout} = \zeta_{inp}$ (Eq. (33)) by substituting p^* (control key). In decision point 3, the calculations are continued to realize $V_{cell} = V_{cell}^*$ by inputting V_{cell}^* (control key) and I/S^* (control key).

V_{cell} is changed step by step in the constant voltage operation.

4.2. Results

Fig. 3 shows ions flux J_S and solution flux J_V across a membrane pair. The data are independent of σ , so we recognize that the fluxes are not influenced by σ , i.e. the fluxes are not influenced by solution velocity distribution between desalting cells.

Fig. 4 shows salt concentration at the outlets of concentrating cells C''_{out} and salt concentration passing through the membrane pair C''^b . C''_{out} is drastically decreased comparing to C''^b . This phenomenon is due to that the feeding solution is supplied to concentrating cells for preventing scale formation in concentrating cells.

Fig.5 shows energy consumption E , which is increased with V_{cell} and not influenced by σ .

I/S and $(I/S)_{lim}$ are plotted against V_{cell} and shown in Fig. 6. Real limiting current density $(I/S)_{lim}$ and real limiting cell voltage $V_{cell,lim}$ at real $(I/S)_{lim}$ of the electro dialyzer is determined from the intersection between the a I/S line and a $(I/S)_{lim}$ line in the figure. The real limiting current density $(I/S)_{lim}$ and real cell voltage $V_{cell,lim}$ depend on σ and they are listed in Table 1.

Salt concentration at the outlets of desalting cells C'_{out} is decreased with the increase of V_{cell} (Fig. 7). We determine salt concentration at the outlets of desalting cells as $C'_{out} = 500$ (WHO drinking water standard), 400, 300 mg/l. Operating cell voltage $V_{cell,ope}$ for producing drinking water ($C'_{out} = 500, 400, 300$ mg/l) is given in Fig. 7 and it is listed in Table 1.

An electro dialysis operation is assumed to become unstable ($V_{cell,ope} > V_{cell,lim}$) in the following conditions.

$$\sigma = 0.1, C'_{out} = 300 \text{ mg/l}$$

$$\sigma = 0.15, C'_{out} = 400, 300 \text{ mg/l}$$

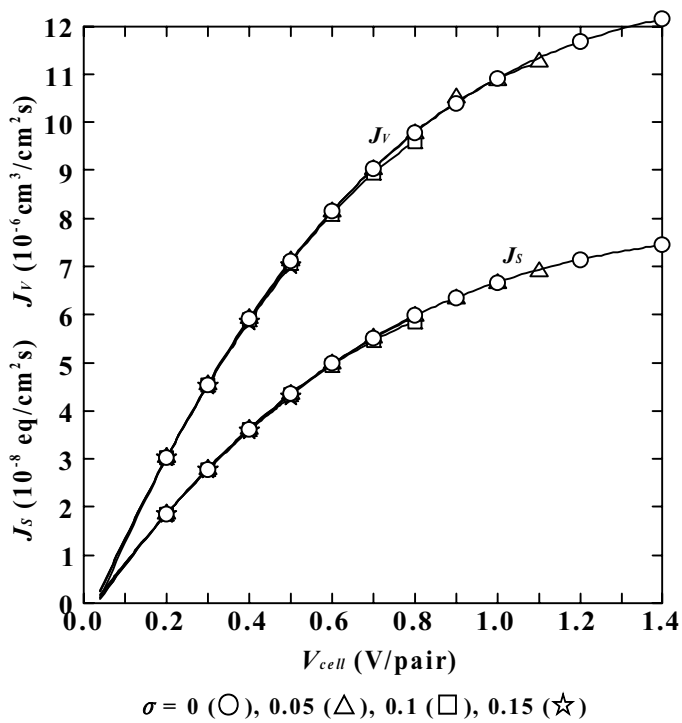

Fig. 3. Ion flux and solution flux across a membrane pair.

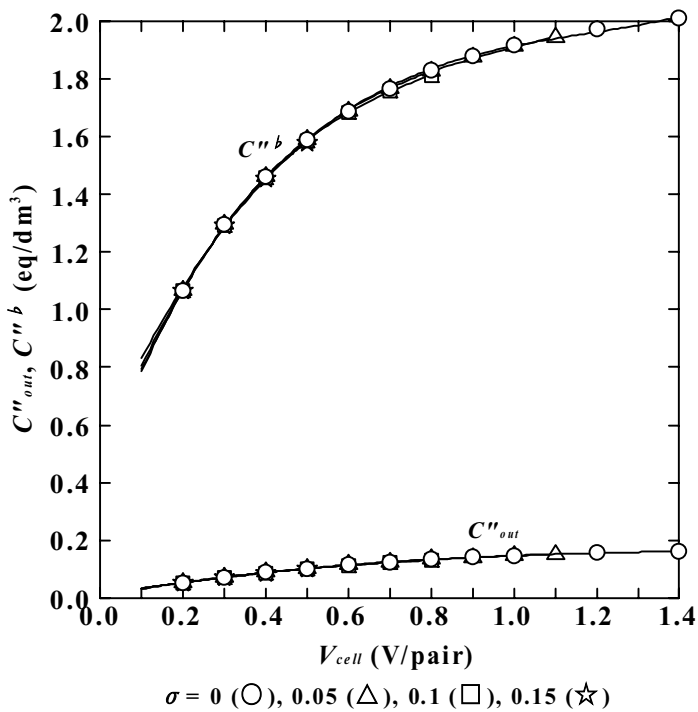

Fig. 4. Salt concentration of a solution at the outlets of concentrating cells and passing through membrane pairs.

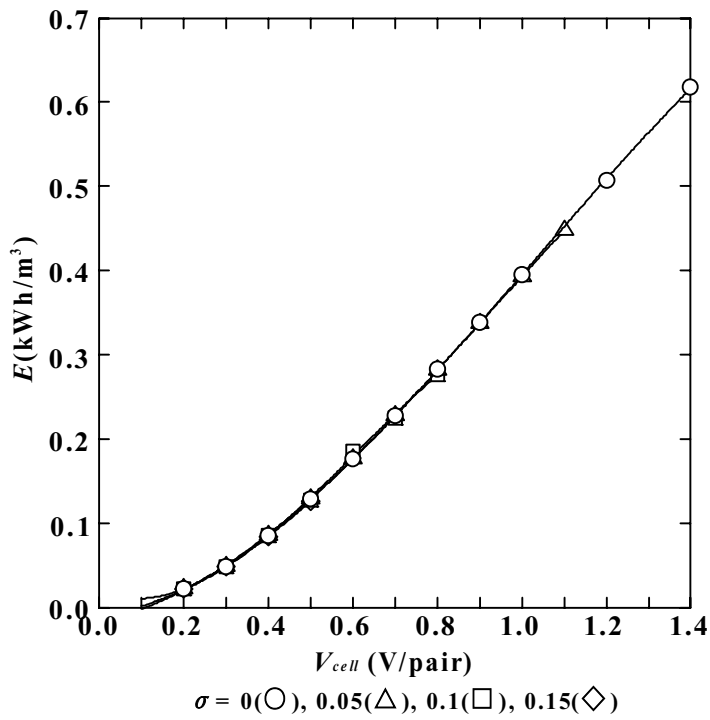

Fig. 5. Energy consumption.

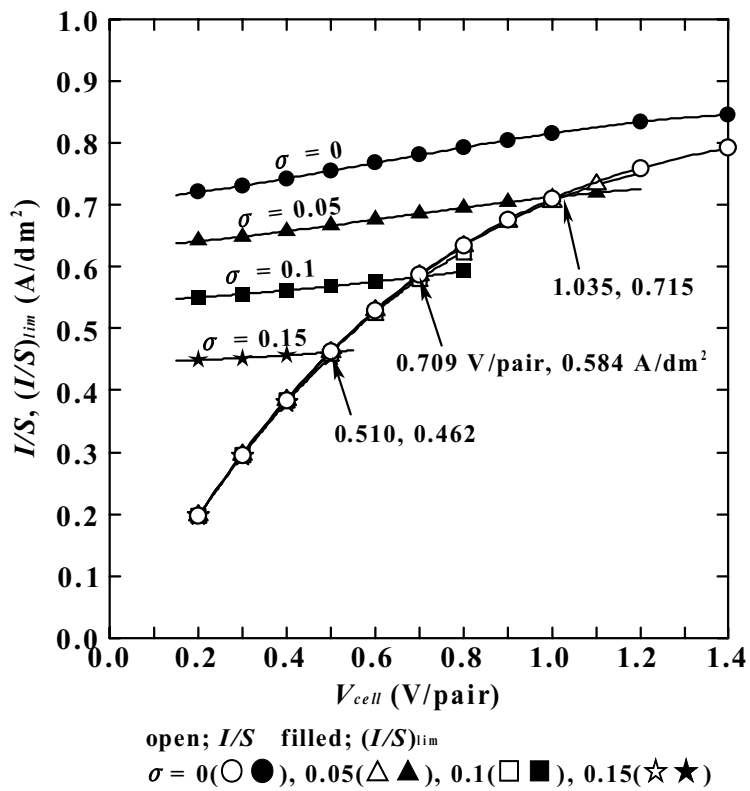

Fig. 6. Current density, limiting voltage and limiting current density.

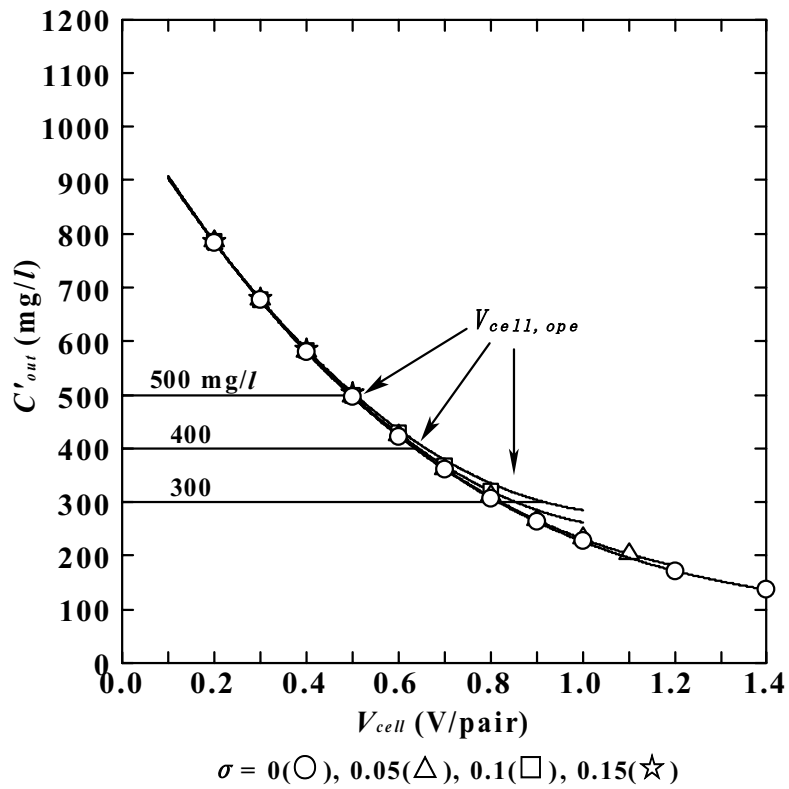

Fig. 7. Salt concentration at the outlets of desalting cells.

Table 1. Limiting cell voltage and operating cell voltage.

σ		0.00	0.05	0.10	0.15
$(I/S)_{lim}$	A/dm ²	undeter- mined	0.715	0.584	0.462
$V_{cell,lim}$	V/pair		1.035	0.709	0.510
C'_{out}		$V_{cell,ope}$			
mg/l		V/pair			
500		0.496	0.496	0.499	0.505
400		0.636	0.638	0.644	0.660
300		0.817	0.822	0.855	0.917

σ is influenced extremely by the precision of part dimensions of a stack and skill of stack assembling work of an electro dialyzer. It is desirable to keep σ values as low as possible, but we can not exactly control σ values in an electro dialysis operation. However, if we assume that σ functions as a safety factor in operating an electro dialyzer, it is significant to determine an appropriate σ value for realizing an stable operation of an electro dilayzer. From this view point, we define $\sigma = 0.1$ as the safety standard deviation factor.

5. CONCLUSION

Electrodialysis program for saline water desalination is developed. 1000 mg/l and 25°C saline water is electro dialyzed for producing drinking water stably to meet WHO drinking water standard. Limiting current density of the electro dialyzer is influenced strongly by the standard deviation of the solution velocity ratio between desalting cells σ . $\sigma = 0.1$ is defined as a safety factor for operating an electro dialyzer stably.

REFERENCES

- Avriel, M. and Zeligher, N. (1972). "A computer method for engineering and economic evaluation of electro dialysis plant", *Desalination*, Vol. **10**, 113-146.
- Belfort, G. and Daly, J. A. (1970). "Optimization of an electro dialysis plant", *Desalination*, Vol. **8**, 153-166.
- Brauns, E., Wilde, W. De, Van den Bosch, B., Lens, P., Pinoy, L. and Empsten, M. (2009). "On the experimental verification of an electro dialysis simulation model for optimal stack configuration design through solver software", *Desalination*, Vol. 249, 1030-1038.
- Fidaleo, M. and Moresi, M. (2005). "Optimal strategy to model the electro dialytic recovery of a strong electrolyte", *J. Membr. Sci.*, Vol. **260**, 90-111.
- Lee, H. J, Sarfert, F., Strathmann, H. and Moon, S. H. (2002). "Designing of an electro dialysis desalination plant, *Desalination*, Vol. **142**, 267-286.
- Moon, P., Sandi, G., Stevens, D. and Kizilel, R. (2004). "Computational modeling of ionic transport in continuous and batch electro dialysis", *Sep. Sci. Technol.*, Vol. **29**, 2531-2555.
- Nikonenko, V. V., Pismenskaya, N. D., Itoshin, A. G., Zabolotsky, V. I. and Shudrenko, A. A. (2008). "Description of mass transfer characteristics of ED and EDI apparatus by using the similarity theory and computation method", *Chem. Eng. Proc.* Vol. **47**, 1118-1127.
- Sadrzadeh, M., Kaviani, A. and Mohammadi, T. (2007). "Mathematical modeling of desalination by electro dialysis", *Desalination*, Vol. **206**, 534-549.

- Tanaka, Y. (2000). "Current density distribution and limiting current density in ion-exchange membrane electrodialysis", *J. Membr. Sci.*, Vol. **173**, 179-190.
- Tanaka, Y., Ehara, R., Itoi, S., Goto, T. (2003), " Ion-exchange membrane electro-dialytic salt production using brine discharged from a reverse osmosis seawater desalination plant", *J. Membr. Sci.*, Vol. **222**, 71-86.
- Tanaka, Y. (2005). "Limiting current density of an ion-exchange membrane and of an electro-dialyzer", *J. Membr. Sci.*, Vol. **266**, 6-17.
- Tanaka, Y. (2006). "Irreversible thermodynamics and overall mass transport in ion-exchange membrane electrodialysis", *J. Membr. Sci.*, Vol. **281**, 517-531.
- Tanaka, Y. (2009). "A computer simulation of continuous ion exchange membrane electrodialysis for desalination of saline water", *Desalination*, Vol. **249**, 809-821.
- Tanaka, Y. (2010a). "Simulation of an ion exchange membrane electrodialysis process for continuous saline water desalination", *Desalination and Water Treatment*, Vol. **22**, 1-15.
- Tanaka, Y. (2010b). "A computer simulation of ion exchange membrane electrodialysis for concentration of seawater", *Membrane Water Treatment*, Vol. **1**, 13-37.
- Tanaka, Y. (2011a). "Ion exchange membrane electrodialysis for saline water desalination and its application to seawater concentration", *Ind. Eng. Chem. Res.*, Vol. **50**, 7494-7503.
- Tanaka, Y. (2011b). "Ion exchange membrane electrodialysis of saline water and its numerical analysis", *Ind. Eng. Chem. Res.*, Vol. **50**, 10765-10777.

NOMENCLATURES

- a flow-pass thickness in a desalting and a concentrating cell (cm)
- b flow-pass width in a desalting and a concentrating cell (cm)
- C electrolyte concentration (eq cm⁻³, eq dm⁻³, mg l⁻¹)
- E energy consumption (kWh m⁻³)
- F Faraday constant (As eq⁻¹)
- i current density (Acm⁻², Adm⁻²)
- I electric current (A)
- I/S average current density (Acm⁻², Adm⁻²)
- J_S ion flux across a membrane pair (eq cm⁻²s⁻¹)
- J_V solution flux across a membrane pair (cm³cm⁻²s⁻¹)
- n divided group number of desalting cells in a stack; $j = 0 - n$
- N number of desalting cells in a stack
- p dimensionless distance from the inlet of a desalting cell at which current density is equal

	to the average current density I/S of an electro dialyzer
Q	solution volume ($\text{cm}^3 \text{s}^{-1}$)
r	electric resistance ($\Omega \text{ cm}^2$)
r_{memb}	direct current electric resistance of a membrane pair ($\Omega \text{ cm}^2$)
R	gas constant ($\text{JK}^{-1} \text{mol}^{-1}$)
Re	water recovery
S	ion-exchange membrane area (cm^2)
t	transport number of ions in a membrane
T	temperature ($^{\circ}\text{C}$, K)
u	linear velocity in desalting and concentrating cells (cm s^{-1})
V_{cell}	cell voltage (V pair^{-1})
V_{memb}	membrane potential (V pair^{-1})
V_{Ω}	Ohmic potential (V pair^{-1})
x	distance from the inlet of a desalting cell (cm)
Y_j	frequency of the linear velocity ratio ξ_j in desalting cell group j

Greek letters

α	desalting ratio
γ	activity coefficient of electrolytes in a solution
ε	volume ratio of a spacer in a desalting and a concentrating cell
ζ	current density non-uniformity coefficient
η	current efficiency
κ	specific conductivity of a solution (mS cm^{-1})
θ	crossing angle of spacer rods (radian)
λ	overall transport number of a membrane pair ($\text{eq A}^{-1} \text{s}^{-1}$)
μ	overall solute permeability of a membrane pair (cm s^{-1})
ξ	linear velocity ratio of solutions in desalting cells
ρ	overall hydraulic permeability of a membrane pair ($\text{cm}^4 \text{eq}^{-1} \text{s}^{-1}$)
σ	standard deviation of normal distribution of linear velocity ratio ξ
ϕ	overall electro-osmotic permeability of a membrane pair ($\text{cm}^3 \text{A}^{-1} \text{s}^{-1}$)
χ	distance between spacer rods (cm)

Subscripts

A	anion-exchange membrane
alter	alternating current electric resistance
dire	direct current electric resistance

- in inlet of a desalting and a concentrating cell
- j group j in the normal distribution within the range of $\xi_j - \Delta \xi_j < \xi < \xi_j + \Delta \xi_j$
- K cation-exchange membrane
- lim limiting current density
- out outlet of a desalting and a concentrating cell
- p point $x = pl$ distant from the inlet of a desalting cell

Superscripts

- ' desalting cell
- “ concentrating cell
- * control key
- # desalting cell in which solution velocity becomes the least
- ‡ solution passing through a membrane pair