

Minimum slab thickness of RC slab to prevent undesirable floor vibration

Mohammad Rakibul Islam Khan¹, *Zafrul Hakim Khan², Mohammad Fahim Raiyan³ and Khan Mahmud Amanat⁴

^{1, 2, 3, 4} *Department of Civil Engineering, Bangladesh University of Engineering and Technology, Dhaka-1000, Bangladesh.*

² khan.zafrul@gmail.com

Abstract:

In recent times, from some practical observations, it has been acknowledged that, building designers try to increase slenderness and lightness of the structural system. Building structure designed without considering or accurately measuring its dynamic properties such as vibration can create discomfort to occupants of the building. An investigation based on 3D finite element modeling of a reinforced concrete building, is carried out to study the natural floor vibration. The objective of this work is to determine the minimum slab thickness of a reinforced concrete building to prevent undesirable vibration. The developed FE model has been successfully applied to simulate past experiments which validated the applicability of the model for further parametric study. The variation of the floor vibration is studied for different slab thickness, span length and floor panel aspect ratio. Based on findings, one empirical equation is suggested which provide minimum slab thickness of a short span RC building to prevent undesirable floor vibration.

1. INTRODUCTION

Structural vibration is one of the important elements of dynamic serviceability. Although most of the times dynamic serviceability does not create any safety hazards to the building structure or its occupants. Building structure designed without considering or accurately measuring its dynamic properties such as vibration can create discomfort to occupants of the building.

Modern buildings are now becoming more flexible, slender and irregular shape. Those are more susceptible to undesirable vibration. Most people are sensitive to the frequency of vibration in the range of 8 Hz to 10 Hz; because some human organs have the frequency ranges from 4 Hz to 8 Hz (Wilson, 1998). If the structures have the frequency bellow 10 Hz, then it creates resonance with human body. This resonance may cause undesirable vibration to the people (Murray, 1997).

^{1, 2, 3} Undergraduate Student

⁴ Professor

Many structures have been damaged due to resonance. Tacoma Narrows Bridge has been destroyed (November 7, 1940) because of resonance caused by wind. In London Millennium foot over bridge became unusable (10 June, 2000) because of resonance. The objective of this study is to prevent undesirable floor vibration by providing required slab thickness.

1.1 Scope of the studies

The objective of the current study is to enlarge knowledge about the vibration response of a RC building floor with change of different parameters. The variation of floor vibration is analyzed with changing of slab thickness, floor panel aspect ratio and span length.

The principle features of this thesis are summarized as follows;

- To develop a 3D finite element model of three storied building.
- Verify the built model with hand calculation and experimental data.
- To perform modal analysis to determine mode shape and frequency.
- Analysis the variation of natural floor frequency with variation of slab thickness.
- Analysis the natural floor frequency with variation of span length and floor panel aspect ratio.
- Build a relation among slab thickness, span length and aspect ratio.
- Determine minimum slab thickness to prevent undesirable floor.

2. LITERATURE REVIEW

Murray et al., (2011) studied on floor vibration characteristic of long span composite slab system. They have done their experiment on a „laboratory floor specimen’ and on a „full scale floor mockup’ and on „laboratory footbridge’. In laboratory floor, they used 9.14m × 9.14m single bay, single storied floor in experimental setup. They used 222 mm composite slab of 24MPa normal weight concrete. The floor was supported only in the perimeter with W530×66 girder and W360×32.9 beam which framed in to W310×60 column. Then the natural floor vibration is calculated, and found 4.98 Hz. The laboratory floor test indicates that long span composite deck has very good resistance to floor vibration due to walking. The floor had natural frequencies that are in the range of those measured for composite slab and composite beam floor system and far above the 3 Hz limit to avoid vandal jumping.

2. METHODOLOGY

A three storied RC 3-D building frame is modeled (Figure1 and 2). Finite element analysis has been used to analyze the dynamic properties of the slab. ANSYS 11 software is used for this analysis. BEAM4, SHELL43 and MASS21 elements are used for beam and column, Slab and for mass source respectively. Modal Analysis (Block Lanczos) has been performed to determine the slab thickness.

3.1 Assumption

The investigation is based on some assumptions, to avoid complexity in calculation. These assumptions are as follows;

- Material is linearly elastic and isotropic.
- No lateral load is considered in this study.
- Live load is only considered to determine beam and column size, and

is not used in determining modal frequency.

- Floor finished load is assumed to be $1.2 \times 10^{-3} \text{ N/mm}^2$

3.2 Model

In the 3-D building frame modeling, it is assumed that all columns are square. The size of edge and exterior columns are 85% and 75% of interior column respectively.

$$P_u = 0.65 \times 0.8A_g \{0.85f'_c + \rho(f_y - 0.85f'_c)\} \quad (1)$$

Where,

$$P_u = (1.4 \times DL + 1.7 \times LL) \times A_c \quad (2)$$

A_c = Contributory Area, mm^2

Gross area of interior column, A_g is taken 25% greater for beam column self weight.

Interior column = $\sqrt{A_g} \geq \text{Beam width}$

Beam depth = $3 \times \text{slab thickness}$

Beam width = $(\text{beam depth}) \div 3 \geq 250 \text{ mm}$

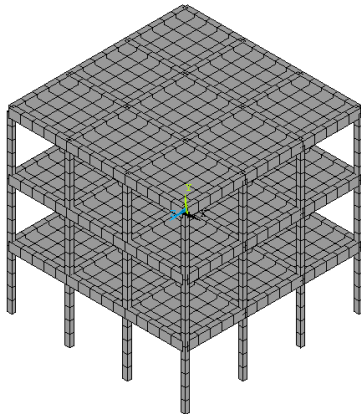

Figure 1: 3-D View of the Model

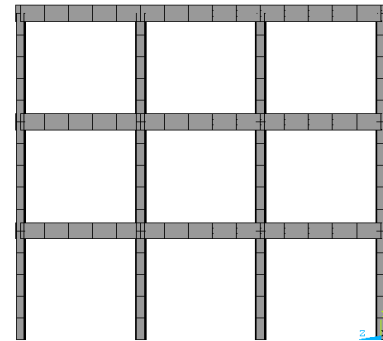

Figure 2: Elevation of the Model

Slab thickness is considered as, span/60, span/55, span/50, span/45, span/40, span/35, span/30, span/25, span/20, and span/15 for this study. Here span is the length of short span in mm.

3.3 Different Mode Shapes

Modal analysis is used to calculate dynamic behavior of the building (frequency). In the case of modal analysis different mode shapes for probable vibration pattern are encountered. Different mode shapes have different frequencies of vibration. Some of the mode shapes with there respect frequencys are featured to give some ideas about the different mode shapes of vibration in dynamic analysis.

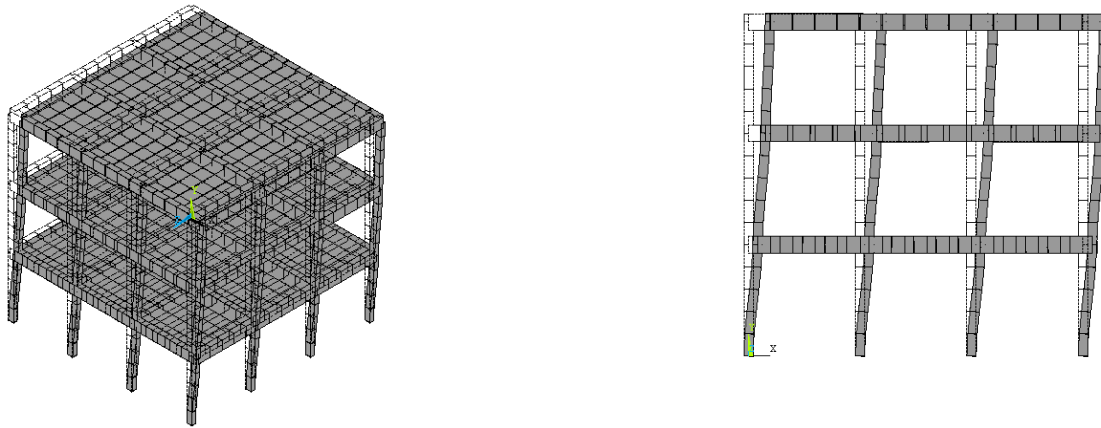

Figure 3: 1st Mode Shape (1.3 Hz)

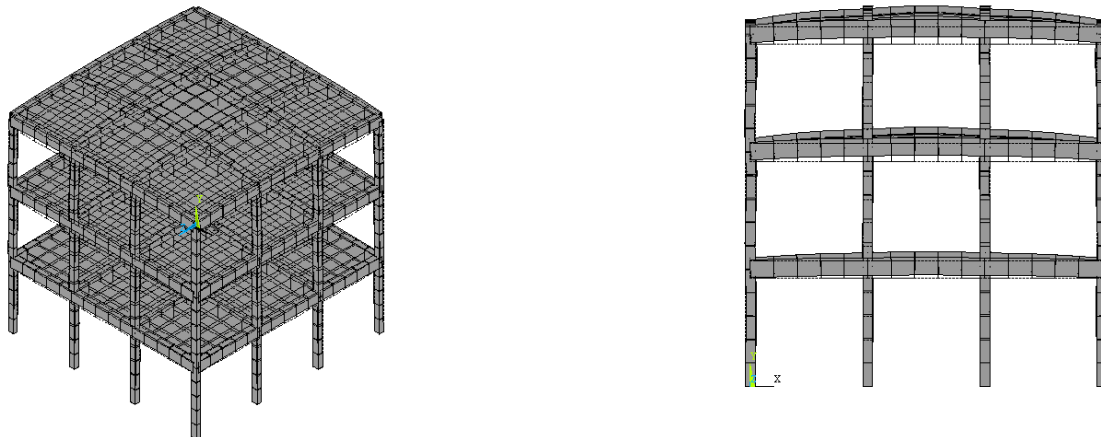

Figure 4: 10th Mode Shape (15.4 Hz)

4. VERIFICATION OF THE MODEL

This section is for validity of the model as if it gives the accurate result or not with experimental values in the laboratory.

Dynamic result given from ANSYS is verified with an experimental result. M. Murray and T. Sanchez (2011), in their research on “Floor Vibration Characteristic Of Long Span Composite Slab System” has done an experiment on a laboratory floor specimen. They measured the floor natural vibration with a vibrato meter. They use a composite floor system with single bay and span.

The laboratory floor (Figure5) was a single 9.14m by 9.14m (30ftby30ft) bay constructed

and tested at the Virginia Tech Thomas M. Murray Structural Engineering Laboratory in 2006. The 222mm (8-3/4in.) composite slab consisted of a 117mm (4-5/8in.) steel deck covered with 105mm (4-1/8in.) of 24MPa (nominal 3.5ksi) normal weight concrete. The floor was supported only at the perimeter with W530×66 (W21×44) girders and W360×32.9 (W14×22) beams which framed into W310×60 (W12×40) steel stub columns. Temporary shoring was provided at the third points of the slab to limit the dead load deflections during the concrete placement. The measured frequency was 4.98 Hz through their experimental setup.

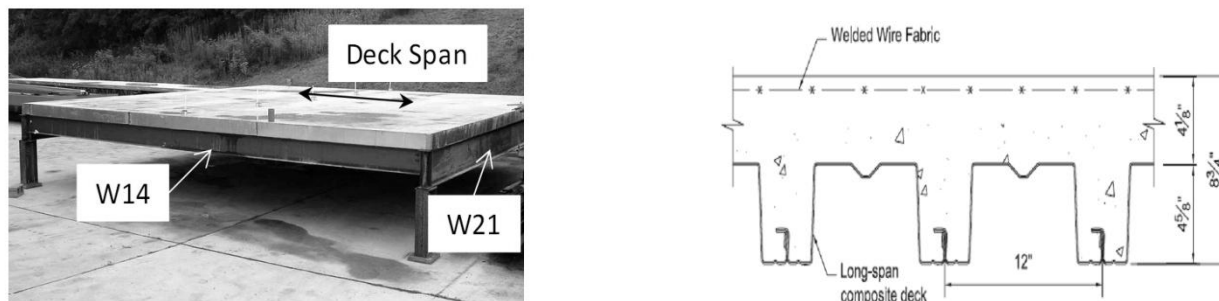

Figure 5: 3-D View and Section View of the Floor (Murray, 2011)

The above experimental setup is modeled (Figure 7) through ANSYS. Here transformed section method (Figure 6) has been used. In the experiment the slab was composite system. But in the model the slab system is not considered as composite. Form equivalent stiffness two modulus of elasticity has been used in two directions (Table 1).

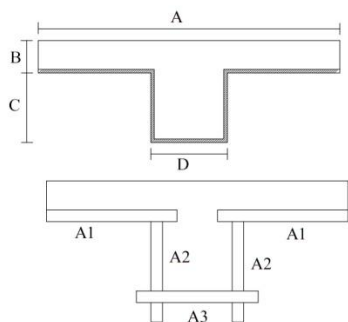

Figure 6: Transformed Slab Thickness

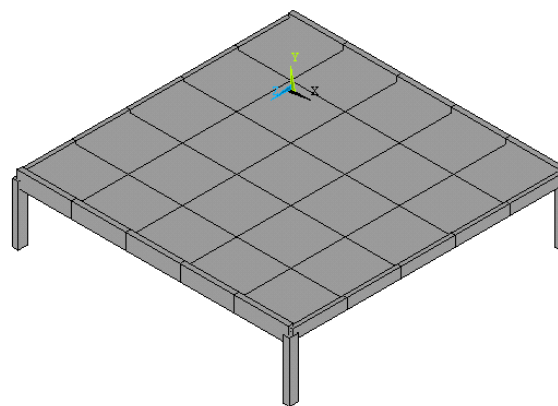

Figure 7: ANSYS modeling view of Laboratory Specimen

After modeling, modal analysis has been performed and the frequency provided from the model is 4.72 Hz, which is close to the experimental result (4.98 Hz).

Table 1: Determination of Equivalent Modulus of Elasticity

Material Properties	
Steel poisson ratio RHO_s	0.25
Concrete poisson ratio RHO_c	0.15

Concrete Modulus of Elasticity, E_c , N/mm ²	20000
Steel Modulus of Elasticity, E_s , N/mm ²	200000
Modular Ratio, $n (=E_s/E_c)$	10

Main Section Dimension	
Width of the Deck , A (mm)	305
Height of the Deck, B (mm)	105
Width of the Girder , D (mm)	100
Height of the Girder, C (mm)	117
Over Hang Length, E (mm)	103
Thickness of Steel Section, t_1 (mm)	2

Transformed Section	
Thickness of section(variable), T (mm)	10
Length of Bottom Slab, h_1 (mm)	206
Height of the Girder, h_2 (mm)	234
Length of Bottom Girder, h_3 (mm)	200

Transformed Area Calculation	
Area of Bottom Slab, A_1 (mm ²)	2060
Area of Perpendicular Girder, A_2 (mm ²)	2340
Area of Bottom Girder, A_3 (mm ²)	2000

Section Properties Calculation X-direction	
Area of the whole Section, (mm ²)	54525
Center Of Gravity from top flange, \bar{y} (mm)	96.03
Inertia about X-axis, I_x (mm ⁴)	645989838.8
Average Inertia, \bar{I} (mm ⁴)	143172029.3

Section Properties Calculation Z-direction	
Transformed Thickness(calculated), (mm)	20
Transformed Area (mm ²)	6100
Area of whole Section (mm ²)	38125
Inertia about Z-axis, I_z (mm ⁴)	538020000

Equivalent Plate Thickness Calculation	
Plate Thickness in X-direction, t (mm)	177.93
Calculation for ' $D_1 = \frac{Et^3}{12(1-\nu^2)}$ ' in X-	9604429451

direction	
Calculation for 'D ₂ ' in Z-direction	2555826279
Transformed Modulus of Elasticity, E ₂	5322.18242

5. PARAMETRIC STUDIES

The study has performed for determining the minimum slab thickness which does not create undesirable floor vibration. The limiting floor vibration frequency is 10 Hz given by Murray (1997). The floor vibration below 10 Hz may create resonance which may cause undesirable floor vibration. So floor vibration above 10 Hz will not create resonance and undesirable vibration. The parameter describe in Table 2 used in the analysis. Author studied on various span length and floor panel aspect ratio. From the study, corresponding slab thickness for 10 Hz (Murray, 1997) frequency is plotted against span length and minimum slab thickness is determined.

Table 2: Values and dimension of the parameters and structural components

Parameter	Values/ Dimension
Span length	3, 4, 5...8 m
Aspect ratio	1, 1.2, 1.4, 1.6, 1.8
Bay width	as per aspect ratio
Floor height	3 m
No. of story	3
No of span	3
No of bay	3
Slab thickness	as per requirement
Floor finish load	1.2×10^{-3} N/mm ²
Partition wall load	2.4×10^{-3} N/mm ²
Live load	4.79×10^{-3} N/mm ²
Beam width	as per requirement
Beam depth	3 × slab thickness
Interior Column	as per requirement
Corner Column	75% of interior column
Edge Column	85% of interior column
Gravitational acceleration	9810 mm/sec ²
Line mesh size	5
Beam Element	BEAM4
Slab Element	SHEEL43
Concrete properties	
Modulus of elasticity	20000 N/mm ²
Poisson's ratio	0.15
Density	2.4045×10^{-9} Ton/ mm ³
Unit weight	2.36×10^{-5} N/mm ²

5.2 Variation Of Floor Vibration With Change Of Span Length

The variation of floor vibration with respect to span length and aspect ratio is studied here. The analysis has been done for normal residential building where average number of population is expected to walk. It is tried to find out the minimum slab thickness which produce vibration more than 10 Hz. As if the structural vibration is larger than the vibration produce by human walking. Murray (1997) has proved that natural frequency less than 10 Hz will cause much discomfort to the occupants. Because humans walking frequency is in the ranges of 2-10 Hz (Setareh, 2010). If the floor natural vibration is less than 10 Hz, it may create resonance, which create much vibration and cause discomfort for the occupants.

The analysis for variation of floor vibration for different span length, slab thickness and aspect ratio has been studied. The modeled structure which has done in the previous section has shown that the beam and column size is depended on the self weight of the structure and the superimposed load (live load). With increasing load (for increase of slab thickness) the beam and column size of the structure also increase and thereby increase the moment of inertia. Hence increase the stiffness of the structure. The stiffness of beam and column can be calculated from the following equation.

$$\text{Stiffness, } k = \sum \frac{12EI}{h^3} \quad (3)$$

Where,

E = Modulus of elasticity, N/mm²

The stiffness of the structural element decrease with increasing length. Hence decrease the natural vibration frequency of the structure. The self-weight and the partition wall load are imposed on the modeled structure as mass element which is a point element. And it is imposed on a node of the structure.

ACI provides the following equation (Eqn 4) for minimum slab thickness to prevent deflection (Serviceability),

$$\text{Minimum Slab Thickness, } t = \frac{L_n \left(0.8 + \frac{F_y}{200000} \right)}{36 + 9\beta} \quad (4)$$

Where,

t = Slab thickness, in

L_n = Clear span length, ft

β = Floor panel aspect ratio

F_y = Steel yield strength, psi

Some typical graphs (Figure 8- Figure17) on variation of floor frequency with respect to slab thickness and minimum slab thickness provided by ACI, for different span length and aspect ratio are as follows,

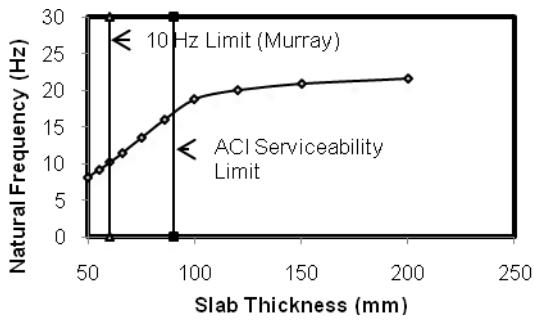

Figure 8: Frequency Vs Slab thicknesses for 3000 mm span and aspect ratio 1

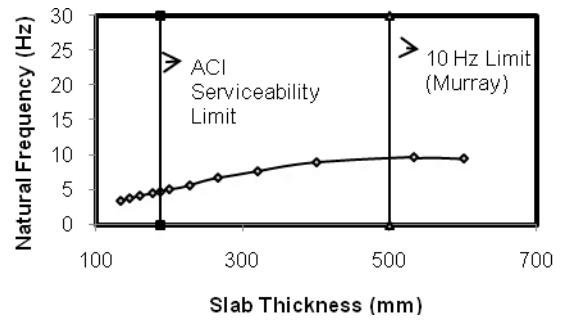

Figure 9: Frequency Vs Slab thicknesses for 8000 mm span and aspect ratio 1

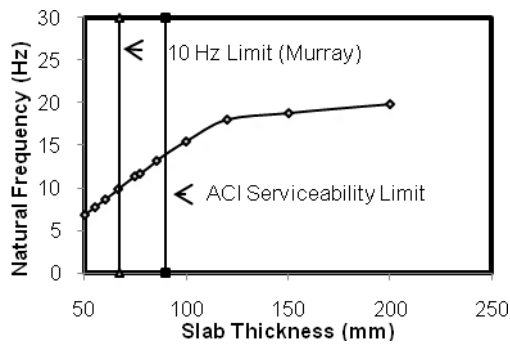

Figure 10: Frequency Vs Slab thicknesses for 3000 mm span and aspect ratio 1.2

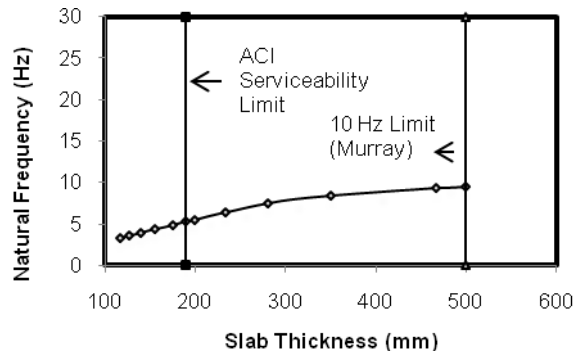

Figure 11: Frequency Vs Slab thicknesses for 7000 mm span and aspect ratio 1.2

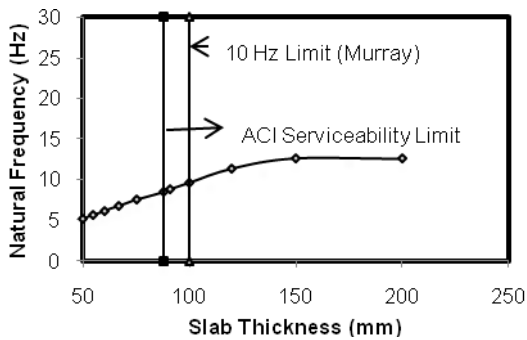

Figure 12: Frequency Vs Slab thicknesses for 3000 mm span and aspect ratio 1.4

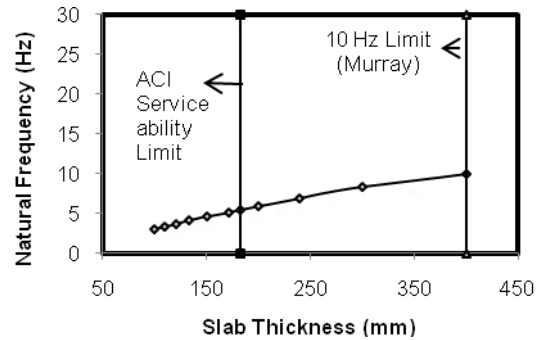

Figure 13: Frequency Vs Slab thicknesses for 6000 mm span and aspect ratio 1.4

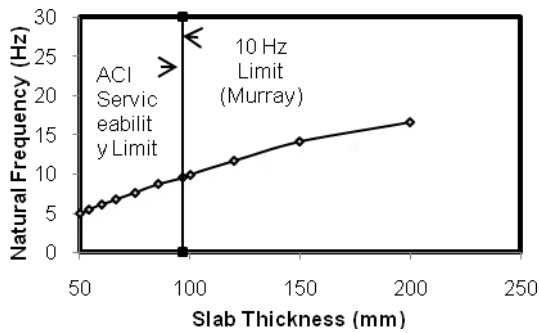

Figure 14: Frequency Vs Slab thicknesses for 3000 mm span and aspect ratio 1.6

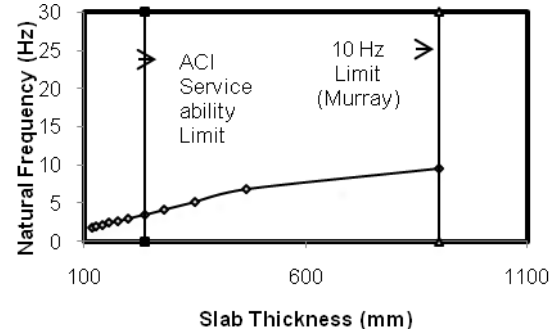

Figure 15: Frequency Vs Slab thicknesses for 7000 mm span and aspect ratio 1.6

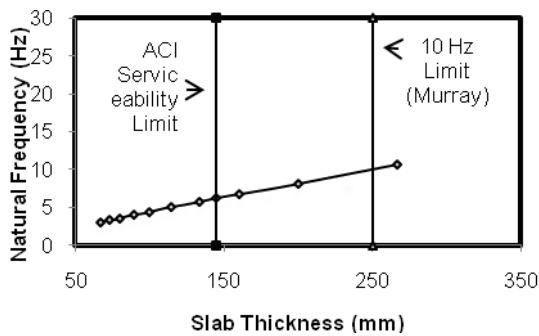

Figure 16: Frequency Vs Slab thicknesses for 4000 mm span and aspect ratio 1.8

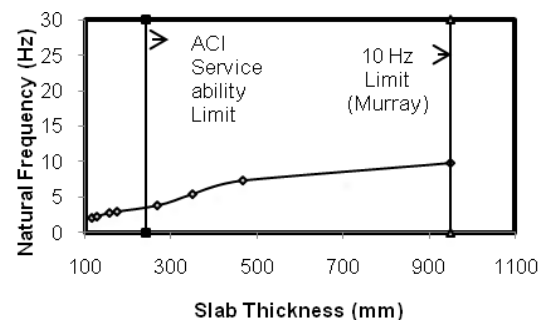

Figure 17: Frequency Vs Slab thicknesses for 7000 mm span and aspect ratio 1.8

5.3 Discussion

From the above Figure 8- Figure17, the change of frequency with change of slab thickness, span length and aspect ratio is shown. Here span length is the shortest distance along the X-direction, and the bay width is the largest distance along Z- direction. From the above figure the following points are observed,

- The natural frequency of floor is increasing with increasing of slab thickness. Because with increasing slab thickness the beam and column size is also increased, due to self weight of the slab. Hence increase the moment of inertia of structural elements and consequently increase the natural frequency of the whole structure.
- With increase of span length the stiffness of beam decrease, so the building vibration is reduced.
- With increase of floor panel aspect ratio the natural frequency of floor is decreasing. Because increased aspect ratio increase the bay width of the building structure. Hence decrease the stiffness of the building element (equation 3). And decrease the floor frequency.
- Increase of slab thickness means the increase of weight of structure and which indicate the increase of mass. Increase of mass means decrease of natural frequency of the structure.

- Increasing mass decrease the floor frequency and increase beam and column size. Which increase the moment of inertia and increases the floor frequency. For these two contradictory conditions, the initial part of the curve mention above in the figure is steeper, and then it becomes flatter.
- At low aspect ratio, the point of changing slope is achieved earlier (at small slab thickness), but with increase of aspect ratio this point gradually shifted toward the larger slab thickness. This condition is also seen with increase of span length. This condition prevails, because initially the moment of inertia is high enough to ignore the effect of reducing frequency due to increasing mass. Then gradually reduced frequency due to increase mass become prominent. And those both affect cause to flatter the curve.
- Due to including the partition wall load, the observed frequency is lesser to some extent with compared to without partition wall load. Because increase partition wall load increase the mass of the structure. Hence decrease the floor vibration frequency.

5.4 Minimum slab thickness determination

Minimum slab thickness would be such thickness which produces 10 Hz frequency for a given set of aspect ratio and span length. In this current study our focused will be confined for short span floor (3m-6m) only. In determination of minimum slab thickness a graph is plotted with the value of slab thickness and span length corresponding to 10 Hz vibration in a slab thickness (mm) Vs span length (m) graph. This procedure is repeated for the aspect ratio of 1, 1.2, 1.4, 1.6, and 1.8. In the same graph paper minimum slab thickness corresponding to span length given by ACI (equation 4) is also presented for visualize the deviation of the thickness for 10 Hz limit (Murray, 1997) with the ACI provided thickness. Here ACI limit means ACI Serviceability Limit, and 10 Hz limit means 10 Hz limit given by Murray (1997).

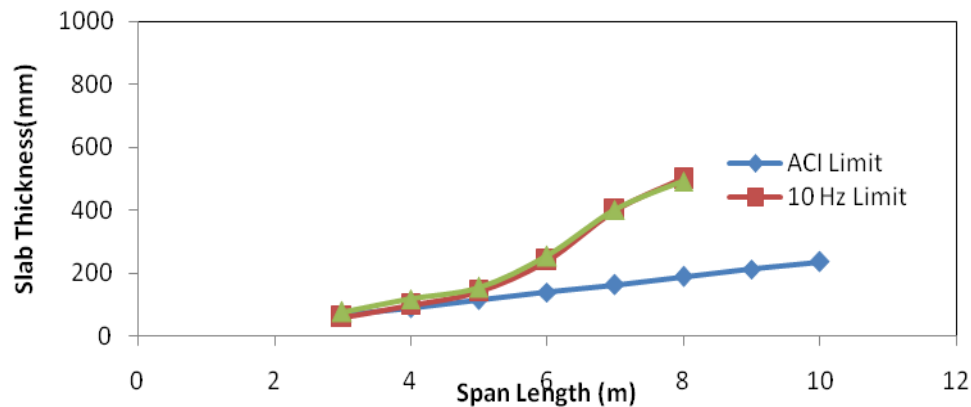

Figure 18: Comparison Of Slab Thickness For Aspect Ratio 1

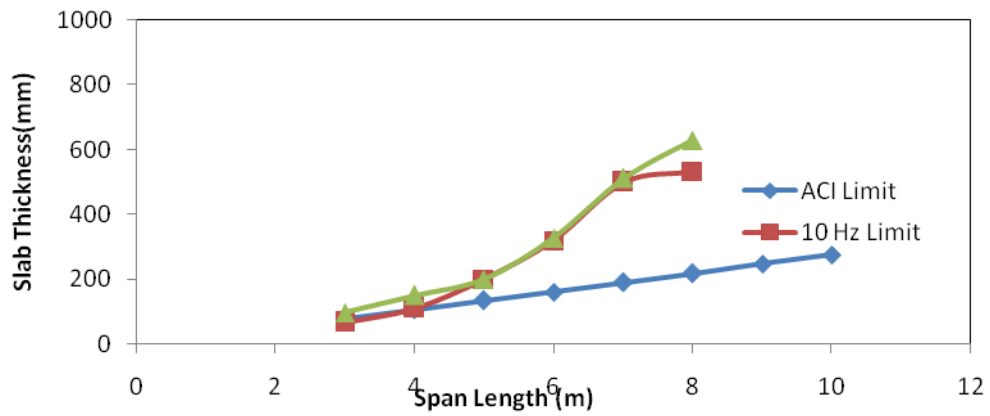

Figure 19: Comparison Of Slab Thickness For Aspect Ratio 1.2

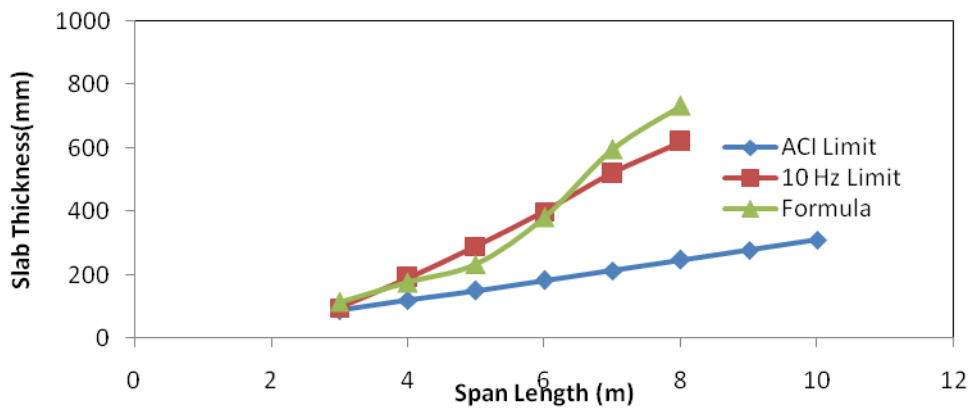

Figure 20: Comparison Of Slab Thickness For Aspect Ratio 1.4

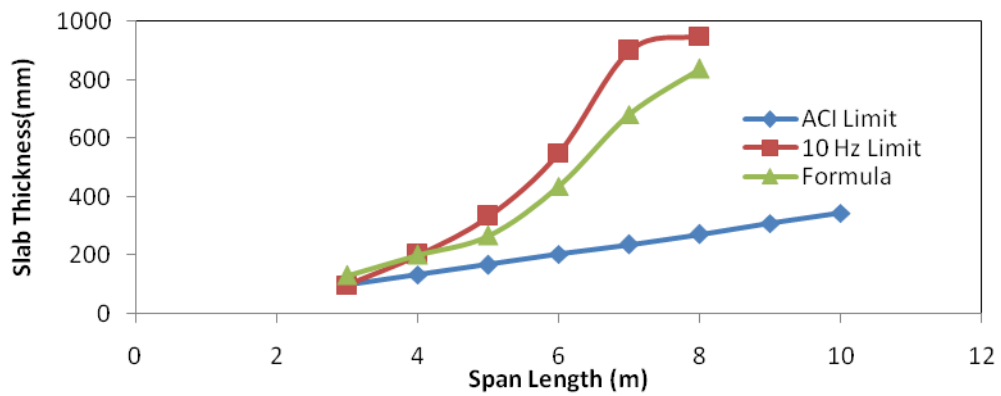

Figure 4.21: Comparison Of Slab Thickness For Aspect Ratio 1.6

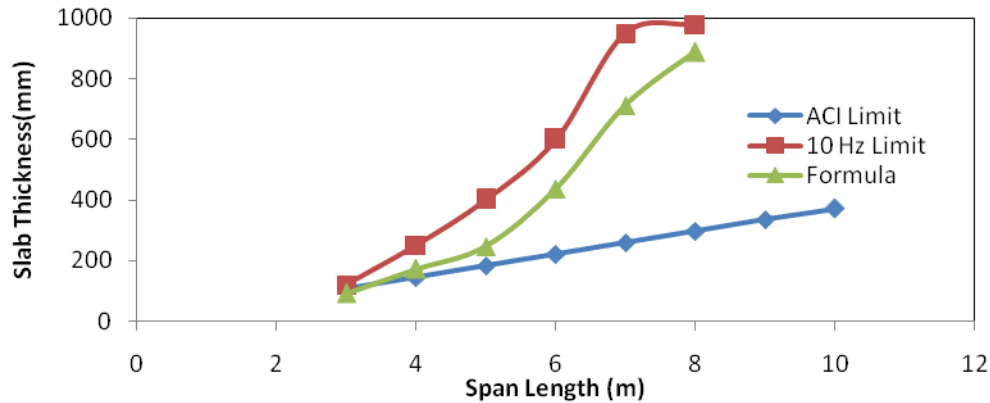

Figure 4.22: Comparison Of Slab Thickness For Aspect Ratio 1.8

From the above variation of the slab thickness with span length, a polynomial equation is formed to determine the trend line of the analysis value. Those trend line for different aspect ratio is analyzed to give a common equation which would give the slab thickness for around 10 Hz vibration as a function of span length and aspect ratio.

The following equation (equation number 5) for short span length is provided for satisfying the above requirement, and the value given from the equation is also plotted in the above figure. To give as much as practical value from the equation no 4.4, floor vibration frequency around 10 Hz is used.

$$t = (-3.541x^4 + 75x^3 - 558x^2 + 1795x - 2050)\beta \quad (5)$$

Where,

- t = Minimum slab thickness for around 10 Hz floor vibration, mm
- x = Short span length, m
- β = aspect ratio.

6. CONCLUSION

In the present study an investigation has been done to determine the required minimum slab thickness from dynamic serviceability. ACI provides a minimum slab thickness (equation 4) to prevent excessive deflection (static serviceability) of the slab. There is no such recommended slab thickness which can prevent undesirable floor vibration. This study provides a guide line about slab thickness with function of span length and aspect ratio, which prevent excessive uncomfortable vibration. This study is done for three storied building with different floor panel aspect ratio.

The general output and findings from the previous chapters are summarized below:

- The modal analysis of the building has done and various modes of vibration, frequency and time period were determined by this analysis. This will help us to understand the behavior of the building structure under vibration.

- The floor frequency decrease with increasing floor panel aspect ratio.
- For span length higher than 5m, slab thickness provided by ACI for deflection may not be good for vibration.
- The floor frequency decrease with increasing column height.
- When the mass of the structure increase, the amplitude of that structure decrease.
- The increasing of slab thickness causes the increase of frequency of the floor.
- With increasing span length the floor frequency is reduced.
- The floor frequency is higher for floor without partition wall load.

7. REFERENCES

Murray, T.M., Sanchez, T.A. (2011) "*Floor Vibration Characteristics Of Long Span Composite Slab System*", Journal of Structural Engineering, ASCE.

Murray, T.M., D. Allen and E. Ungar, (1997), Design Guide No. 11 "*Floor Vibrations Due to Human Activity*," American Institute of Steel Construction (AISC), Chicago, IL.

Setareh, M. (2010), "*Vibration Serviceability Of A Building Floor Structure I: Dynamic Testing And Computer Modeling*", Journal Of Performance Of Construction Facilities, ASCE.

Wilson, A. (1998), "*Expected Vibration Performance Of Wood Floors As Affected By MSR Vs. VSR Lumber E-Distribution*," Master Degree Thesis, Virginia Polytechnic Institute and State University.