

## **Effect of reducing tsunami damage by installing fairing in Kesen-Bridge**

\*Takahiro Abukawa<sup>1)</sup>, Yuto Nakamura<sup>2)</sup> and Akira Hasegawa<sup>3)</sup>

<sup>1)</sup>, *Department of Design, CHODAI, Sendai 984-0051, Japan*

<sup>2), 3)</sup> *Department of Civil Engineering, Hachinohe Institute of Technology,  
Hachinohe 031-8501, Japan*

<sup>1)</sup> [abukawa-t@chodai.co.jp](mailto:abukawa-t@chodai.co.jp)

### **ABSTRACT**

The 2011 off the Pacific coast of Tohoku Earthquake brought serious damage around the Tohoku district in Japan, and much human life and fortune were lost. Bridges were damaged by this earthquake. It was the most serious damage that the superstructures of bridges were flowed out by tsunami. Earthquakes of the same scale are predicted in other areas of Japan. It is necessary to take measures for bridges near coast. Therefore, we have focused on fairing that is effective in wind resistant stability. We have verified the effect installing it to reduce the force of tsunami acting to bridge by experiment.

### **1. INTRODUCTION**

The 2011 off the Pacific coast of Tohoku Earthquake brought serious damage around the Tohoku district in Japan, and much human life and fortune were lost. Although many bridges suffered damage from this earthquake, the damage in which superstructure flowed out by tsunami was the most serious.

Especially, as for Kesen-Bridge which was erected on National Highway, superstructure was flowed out to about 300m upper stream. Therefore, National Highway which is an important route was blocked off, and it became a significant delay in relief and restoration. Important highways are required to ensure the function, as an emergency route in disaster. It is necessary to carry out tsunami resistant design along with earthquake resistant design. However, tsunami resistant design has not yet been established. Large earthquakes have been predicted in Japan, measures are needed.

Tsunami off the west coast of northern Sumatra earthquake 2004 since occurrence, researches have been advanced about influence on bridge by tsunami. KOSA et al (2007) conducted a damage survey of the bridge by the tsunami of Sumatra earthquake. Furthermore, it is verified by the numerical analysis for bridge damaged. According to the research of Nii et al (2009), experiments have been conducted to evaluate the tsunami force acting on the RC simple girder bridge. According to

---

<sup>1)</sup> Engineer

<sup>2)</sup> Student

<sup>3)</sup> Professor

research on Zhang et al (2010), they conducted experiments installed fairing on the side of the RC simple girder bridge that was damaged by the Indian Ocean Tsunami. In the experiment, effectiveness of the fairing is shown.

In this paper, we conducted experiments in Kesen-Bridge which is a steel girder bridge, and focused on the effectiveness of two kinds of fairing shapes. One is fairing of Box-shape to be installed so as to surround the bridge girder. Another is fairing of L-shape to be installed on side of bridge girder. We verified whether it is possible to reduce force of tsunami, by installing these fairings.

**2. EXPERIMENTAL METHOD**

**2.1 Bridge model**

Target bridge of experiment is Kesen-Bridge. Table 1 shows the overview of Kesen-Bridge, and Fig.1 shows the damaged situation. Main girder was swept away to 300m upstream. Part of the RC slab was swept away to 500m upstream. In rubber bearings, ruptures were seen on bolt and laminated rubber. Piers and abutments had not received serious damage. Considering the size of experimental flume, bridge model was set at scale 1/50 as Fig.2. Bridge model was made by transparent acrylic. Bridge railing was not installed in the bridge model considering the effect to be small.

Table 1 Overview of Kesen-Bridge

Bridge Name	Kesen Bridge
Highway Name	National Highway 45
Bridge length	181.5m
Span length	3@35.97+2@35.97
Effective width	12.5m(2.0m+4.25m+4.25m+2.0m)
Year of construction	1982
Superstructures	Continuous steel plate girder bridge
Substructures	Inverted T-type RC abutments
	Wall type RC piers



Fig.1 Damaged Situation of Kesen-Bridge

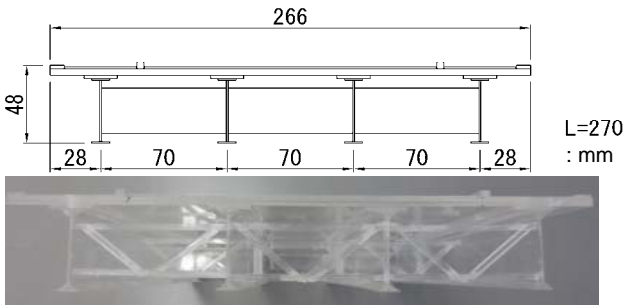

Fig.2 Experimental Model (1/50 Scale Kesen-Bridge)

## 2.2 Experimental flume

Fig.3, 4, and 5 show photo of experimental flume, sluice gate, and side of sluice gate. Fig.6 and 7 show side view of experimental flume and cross-sectional view. Total length of the experimental flume is 16.99m; upstream side and downstream side are 5.69m, 11.30m in length respectively. Sluice gate of stainless steel is disposed between them.

Waves are generated by pulling up the sluice gate. Experiments were carried out by installing the bridge model to position of 5.0m from sluice gate. Partition plate was installed to split the flume. Bridge model was installed on the right side; current meter was installed on the left side.



**Fig.3** Experimental Flume



**Fig.4** Sluice Gate

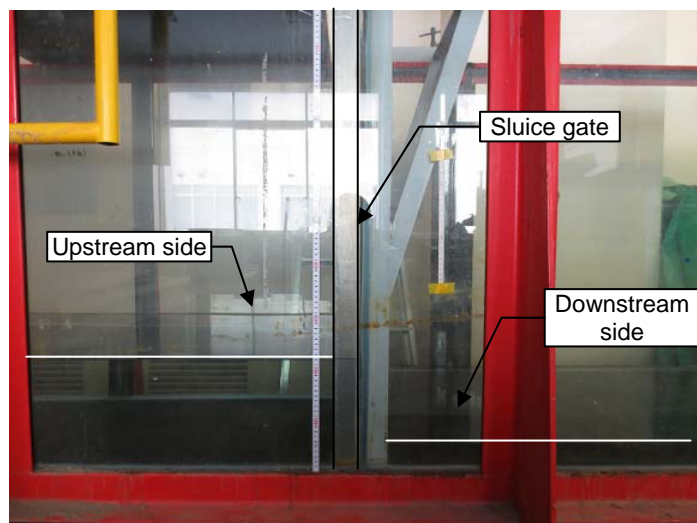

**Fig.5** Side of Sluice Gate

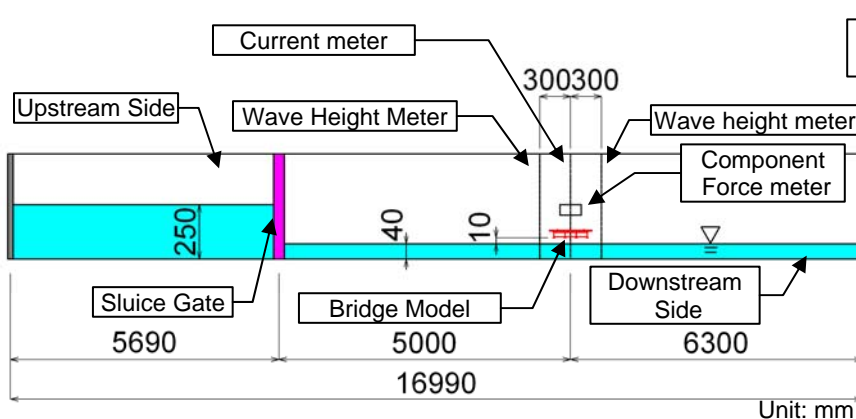

**Fig.6** Side View of Experimental Flume

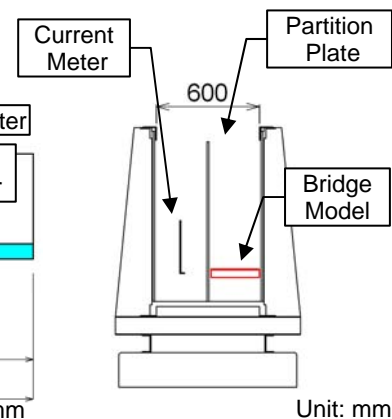

**Fig.7** Cross-sectional View

### 2.3 Measurement equipment

Fig.8, 9 and Fig.10 show installation status of the measuring equipment. Measurement equipment is the following configuration; component force meter (horizontal and vertical), wave height meters, current meter. Component force meter was installed in the top of bridge model. Wave height meter was installed at position upstream and downstream 30cm from center of the bridge model. Current meter was installed on back side of the partition plate; on center position of the bridge model. In addition, situations of the wave collision were taken with a video camera from the side.

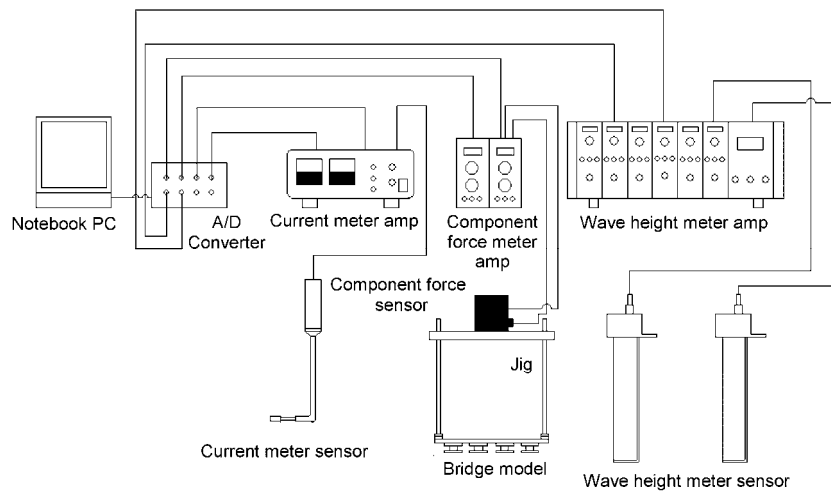

**Fig.8** Measuring Equipment

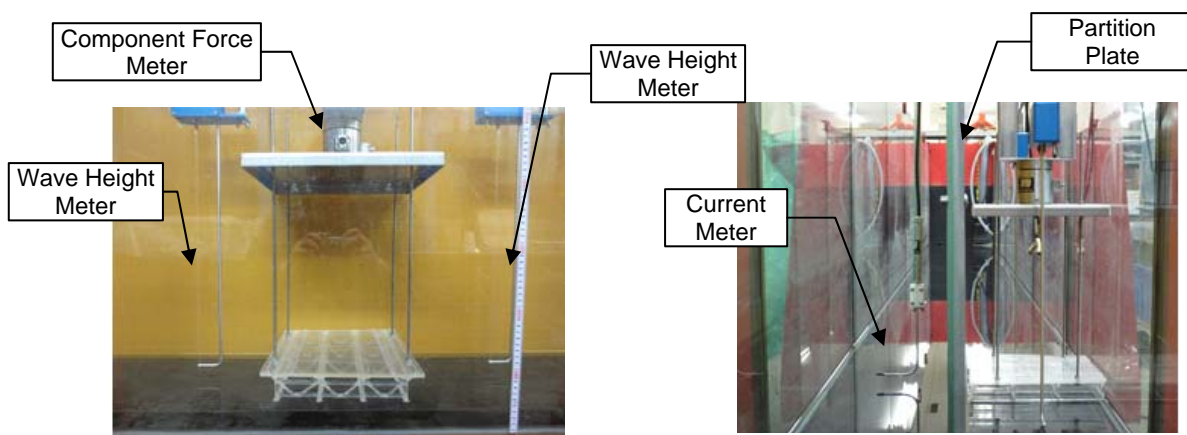

**Fig.9** Installation Conditions (Side)

**Fig.10** Installation Conditions (Front)

## 2.4 Flow velocity

It is estimated the average of flow velocity of the tsunami is 7.0m/sec (ZHENG 2013), from video of suspended matter to be swept away by the tsunami in the vicinity of Kesen-Bridge. Therefore, the flow velocity of the experimental wave was calculated as constant Froude number.

Eq. (1), (2) and (3) show. Experimental Flow velocity was set to be 1.0m/sec from the equation. Therefore, calibration was performed. As a result, by setting water level upstream and downstream for 25cm and 4cm, experiment flow velocity was found to be 1.0m/sec. However, the flow velocity had not accord exactly with 1.0 m/sec. Because horizontal drag is derived from Eq. (4), measured value is corrected by Eq. (5). In this paper, the experimental value indicates a value after correction.

$$Fr = \frac{V_R}{\sqrt{gL_R}} = \frac{V_M}{\sqrt{gL_M}} \quad (1)$$

$$N = \frac{L_R}{L_M} \quad (2)$$

$$V_M = \frac{V_R}{\sqrt{N}} = \frac{7.0}{\sqrt{50}} = 1.0m/sec \quad (3)$$

$$F = \frac{1}{2} \rho_w \times C_d \times A \times V^2 \quad (4)$$

$$F_M = F_{Mi} \times \frac{V_M^2}{V_{Mi}^2} = F_{Mi} \times \frac{1.0}{V_{Mi}^2} \quad (5)$$



where

$V_R$ : Flow velocity of the real (2011 tsunami),  $V_M$ : Flow velocity of the model,  
 $L_R$ : Length of the real,  $L_M$ : Length of the model,  $g$ : Acceleration of gravity,  $N$ : scale,  
 $\rho_w$ : Water density,  $C_d$ : Drag coefficient,  $A$ : Projected Area,  $V$ : Flow velocity.

### 2.5 Shape of the fairing



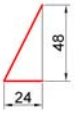
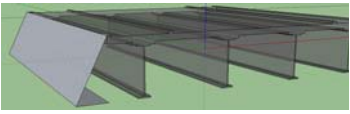
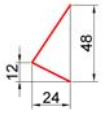
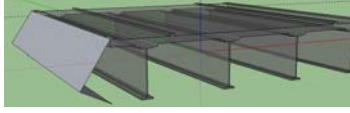
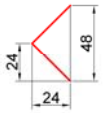
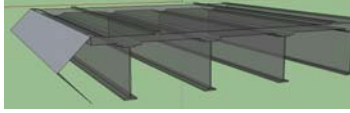
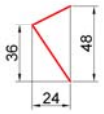
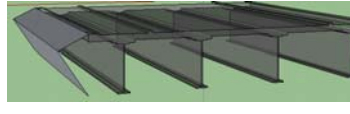

Two shapes for fairings were prepared. Those are Box-shape fairings and L-shape fairings installed in the side surface. L-shapes were set to five types of F1- F5 shown in Table 2. Box-shapes were set to three types of FB0-FB2 shown in Table 3. Side shape of Box-shape fairing was adopted F2 which it had reduced the most force according to the past thesis. The Model that has not installed the fairing is called as F0. Fairing is made of stainless steel and the thickness is 1mm. It has been installed in the model with bolts.

Table 2 L-shape Fairing

	Size	Cubic diagram
F1		
F2		
F3		
F4		
F5		

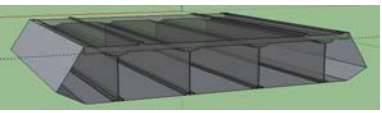
Unit: mm

Table 3 Box-shape Fairing

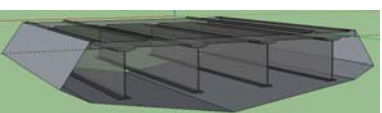
	Size	Cubic diagram
FB0	Size	
	Cubic diagram	
FB1	Size	
	Cubic diagram	
FB2	Size	
	Cubic diagram	

Unit: mm

### 3. Results and Discussions

#### 3.1 Situation of waves acting on F0 model (impact-state, steady-state)

In case of F0 which is not installed the fairing, the response waveform of the force component meter is shown in Fig.11. Value is corrected to the flow velocity 1.0m/sec.

$F_x$  shows horizontal drag.  $F_z$  shows force in the vertical direction, in addition positive direction indicates downward force, and negative direction indicates upward force.  $F_x$  shows the maximum value immediately after the wave collides.  $F_z$  shows the maximum value of upward 0.1 and 0.2 seconds later, after the wave collision. Thereafter, downward force is maximized. Situation which has received the impact force continued about one second. Between 0 and 1.0 seconds after the collision wave are defined as an impact-state. Thereafter,  $F_z$  and  $F_x$  have remained stable. Between 2.0 and 5.0 seconds after the collision wave are defined as a steady-state. Experiment was carried out three times and the average was calculated.

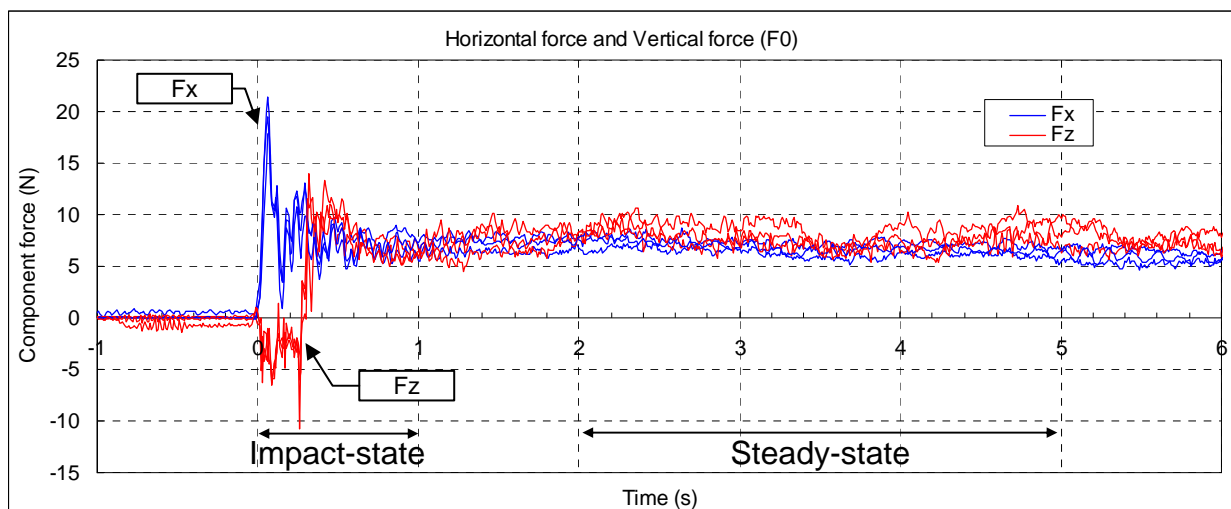

Fig.11 Time-history waveforms of the force component meter (F0)

### 3.2 Effect of side fairing

Table 4 and Fig.12-14 show the value of the force component meter, at F0 and F1-F5 which were installed L-shape fairing. Fig.15 shows their waveforms. By installing the L-shape fairing, horizontal drag Fx at impact-state was reduced about 60-90% compared with F0. In particular, F1-F4 were significantly reduced about 60-70% compared with F0. It is considered that the water flow becomes smooth by installing the fairing to the side of the model. Fz (+) was reduced about 70% compared with F0 on steady-state in case of F3, F4. However, upward force is increased in Fz (+) at the impact-state, it cannot be expected the reduction effect for Fz (+). Compared with Fx, Fz can be seen that dispersion is large. Because air is inside the fairing, the air acted as buoyancy without being discharged. Further, it is presumed that discharge of the air is not constant.

Table 4 Maximum Value of The Force Component Meter in L-shape Fairing

			1st	2st	3st	Ave	Rate
F0	impact-state	Fx(+)	19.51	17.91	21.39	19.60	—
		Fz(-)	-6.33	-6.56	-10.79	-7.89	—
		Fz(+)	11.52	14.01	13.31	12.95	—
	steady-state	Fx(+)	7.29	6.24	6.84	6.79	—
		Fz(+)	8.81	7.17	7.74	7.91	—
F1	impact-state	Fx(+)	10.94	14.48	9.85	11.76	0.60
		Fz(-)	-13.42	-11.03	-5.60	-10.02	1.27
		Fz(+)	13.63	18.75	12.68	15.02	1.16
	steady-state	Fx(+)	5.15	7.45	5.23	5.94	0.88
		Fz(+)	10.36	13.90	9.82	11.36	1.44
F2	impact-state	Fx(+)	13.13	14.91	13.83	13.96	0.71
		Fz(-)	-8.29	-8.46	-11.27	-9.34	1.18
		Fz(+)	12.45	15.52	14.50	14.15	1.09
	steady-state	Fx(+)	6.72	7.05	6.52	6.76	1.00
		Fz(+)	11.02	11.60	10.47	11.03	1.40
F3	impact-state	Fx(+)	13.22	12.81	13.04	13.02	0.66
		Fz(-)	-10.78	-20.14	-13.41	-14.77	1.87
		Fz(+)	10.91	13.38	12.61	12.30	0.95
	steady-state	Fx(+)	8.00	8.57	7.45	8.01	1.18
		Fz(+)	5.67	6.05	5.81	5.84	0.74
F4	impact-state	Fx(+)	13.06	14.17	12.19	13.14	0.67
		Fz(-)	-10.62	-8.92	-12.88	-10.81	1.37
		Fz(+)	12.51	13.13	12.78	12.81	0.99
	steady-state	Fx(+)	7.47	8.64	7.98	8.03	1.18
		Fz(+)	4.57	6.19	5.99	5.58	0.71
F5	impact-state	Fx(+)	15.50	16.73	20.02	17.42	0.89
		Fz(-)	-10.82	-11.18	-14.40	-12.13	1.54
		Fz(+)	18.19	15.86	21.22	18.42	1.42
	steady-state	Fx(+)	7.79	7.06	8.07	7.64	1.13
		Fz(+)	11.43	9.08	10.84	10.45	1.32



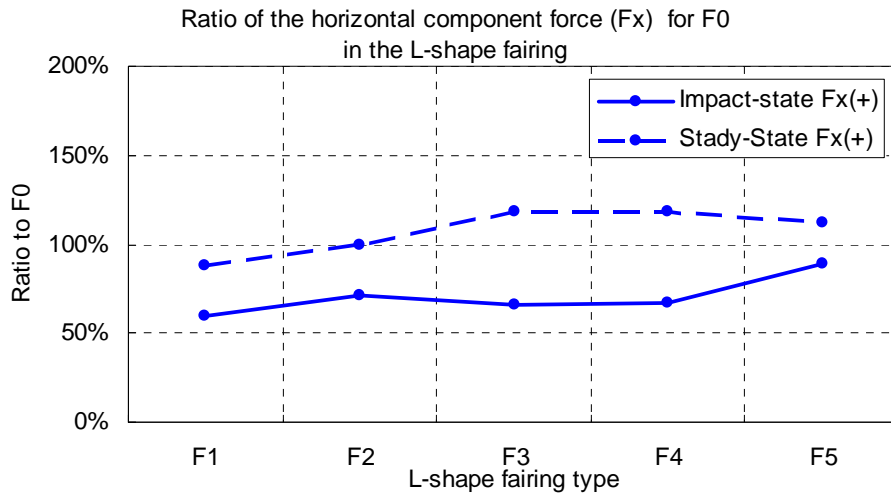

Fig.12 Ratio of the Horizontal Component Force (Fx) for F0 in the L-shape Fairing

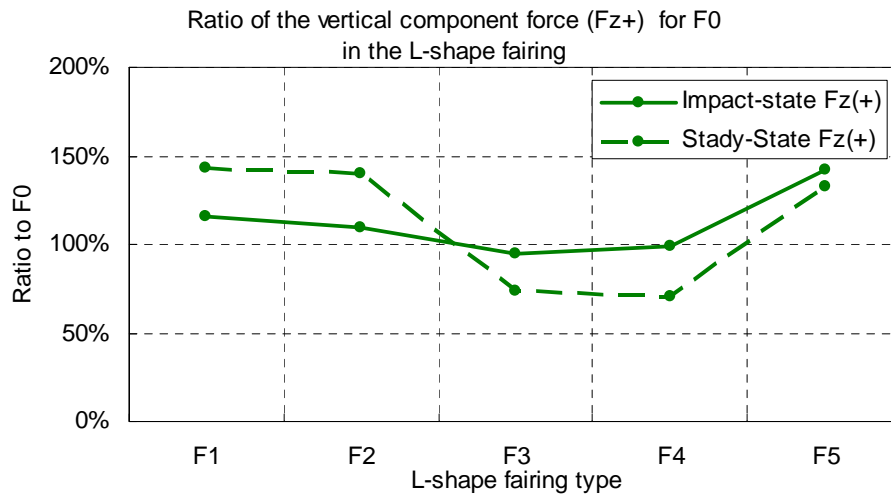

Fig.13 Ratio of the Vertical Component Force (Fz+) for F0 in the L-shape Fairing

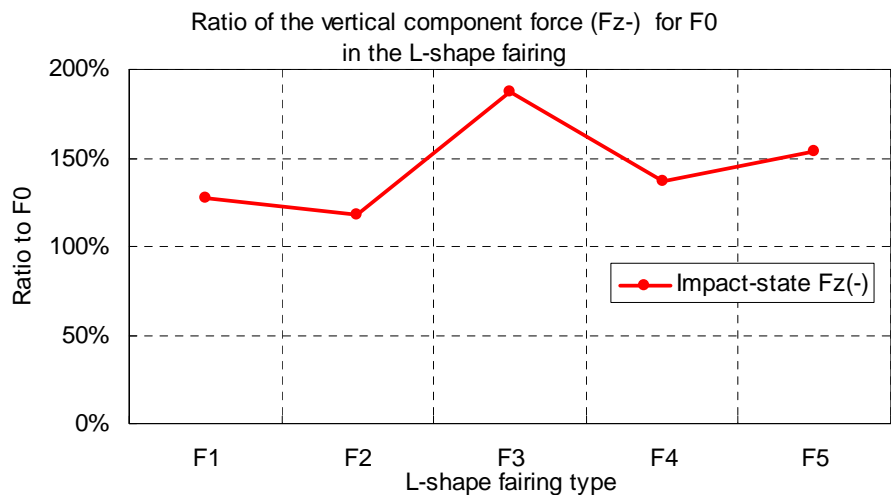

Fig.14 Ratio of the Vertical Component Force (Fz-) for F0 in the L-shape Fairing

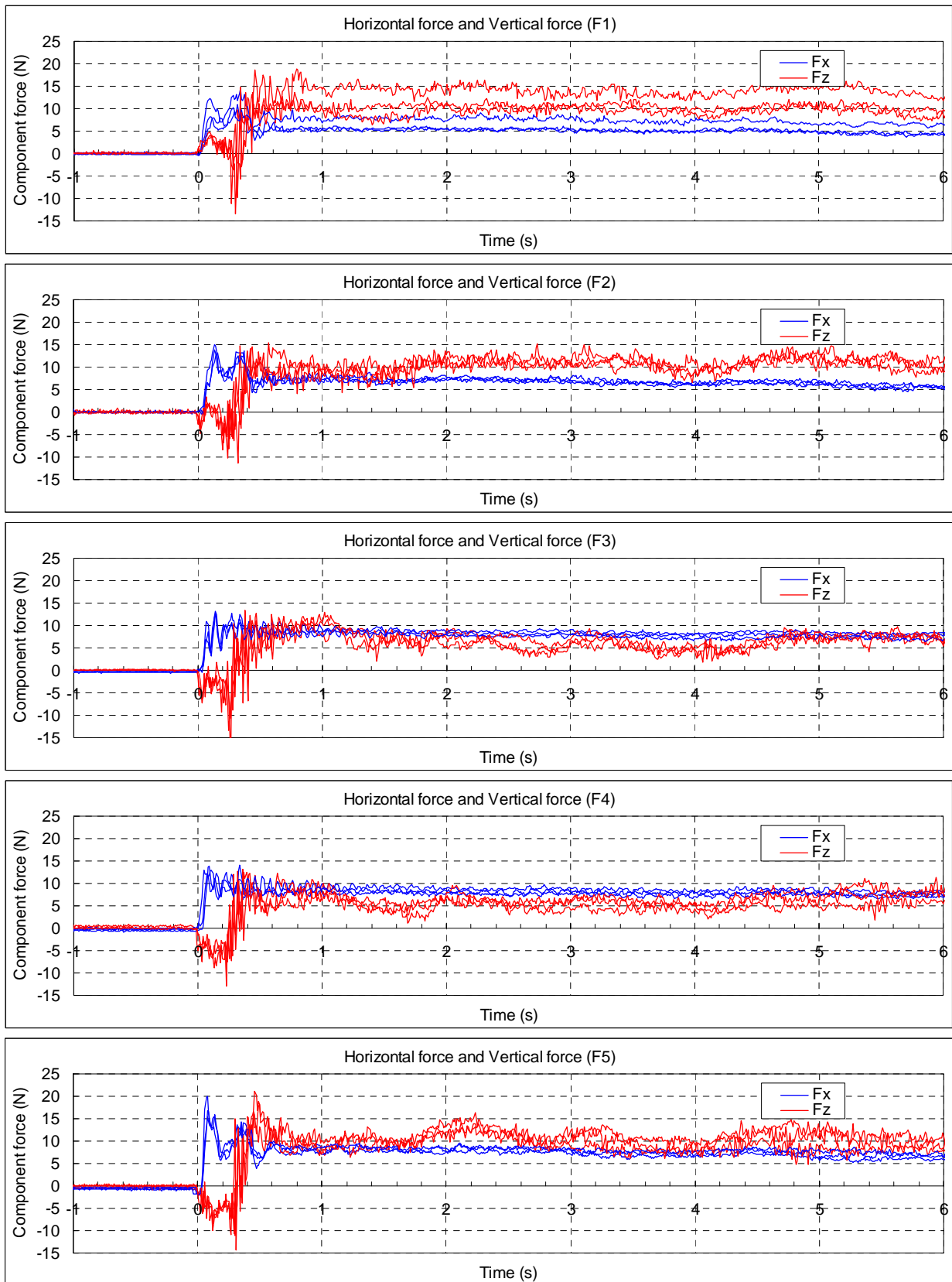

Fig.15 Time-history Waveforms of the Force Component Meter (F1-F5)

### 3.3 Effect of Box-shape fairing

Table 5 and Fig.16-18 show the value of force component meter at FB0-FB2 which were installed Box-shape fairing. Fig.19 shows their waveforms. By installing the Box-shape fairing, horizontal drag  $F_x$  at impact-state was reduced about 40-50% compared with F0. In addition horizontal drag  $F_x$  at steady-state was reduced about 60-70% compared with F0. By using Box-shape fairing, better reduction effect of the horizontal drag as compared with the L-shape fairing was obtained. The Box-shape fairing can reduce horizontal resistance value, and so it is possible to smooth the flow of water.

In the vertical force  $F_z$ , component forces in both steady-state and impact-state have increased significantly compared with F0. The closed space of the Box-shape receives buoyancy. Table 4 shows buoyancy of the Box-shape fairing. The buoyancy acts as a large upward force, between 36N and 43N. In addition, an upward force is increased in the order of FB0, FB1 and FB2. It seems that upward force was increased because clearance was narrowed, by the fairing was inflated to underside of the main girders.

Table 5 Maximum Value of the Force Component Meter in Box-shape Fairing

			1st	2st	3st	Ave	Rate
FB0	impact-state	Fx(+)	8.42	9.36	8.40	8.73	0.45
		Fz(-)	-17.59	-19.07	-17.52	-18.06	2.29
		Fz(+)	9.97	11.62	10.55	10.71	0.83
	steady-state	Fx(+)	4.53	4.44	4.22	4.39	0.65
		Fz(+)	11.65	10.78	10.65	11.03	1.39
FB1	impact-state	Fx(+)	9.14	11.39	9.91	10.15	0.52
		Fz(-)	-18.10	-19.73	-19.96	-19.26	2.44
		Fz(+)	11.40	12.76	9.79	11.32	0.87
	steady-state	Fx(+)	4.49	5.05	4.31	4.62	0.68
		Fz(+)	12.89	13.39	11.91	12.73	1.61
FB2	impact-state	Fx(+)	10.64	10.33	11.17	10.72	0.55
		Fz(-)	-33.36	-26.50	-35.53	-31.80	4.03
		Fz(+)	15.03	12.77	14.11	13.97	1.08
	steady-state	Fx(+)	5.41	5.09	4.93	5.14	0.76
		Fz(+)	16.14	15.55	14.49	15.39	1.95

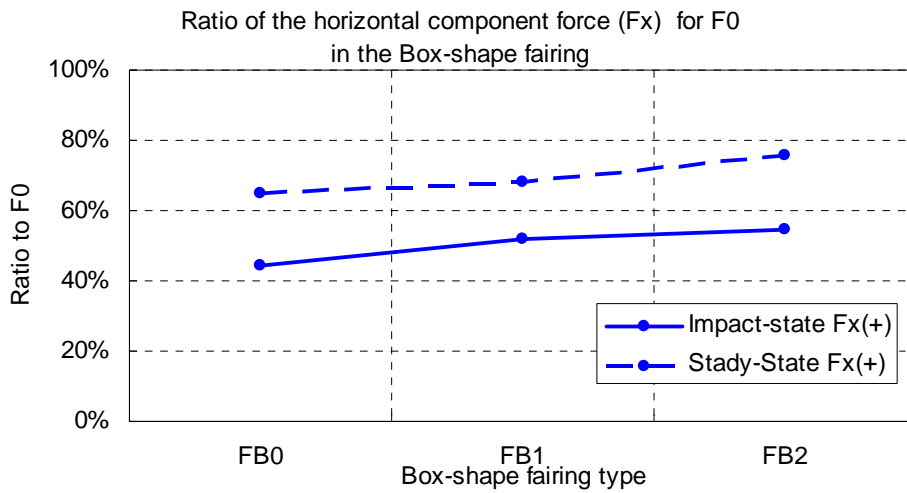

Fig.16 Ratio of the Horizontal Component Force ( $F_x$ ) for  $F_0$  in the Box-shape Fairing

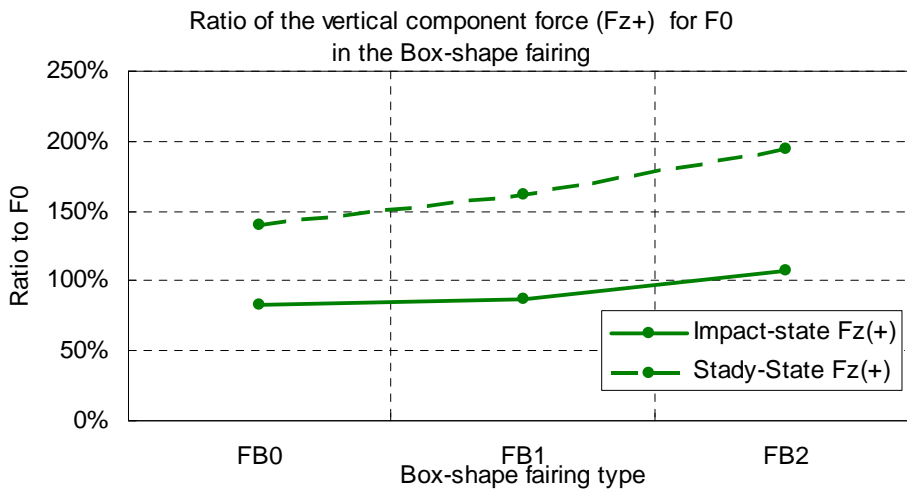

Fig.17 Ratio of the Vertical Component Force ( $F_{z+}$ ) for  $F_0$  in the Box-shape Fairing

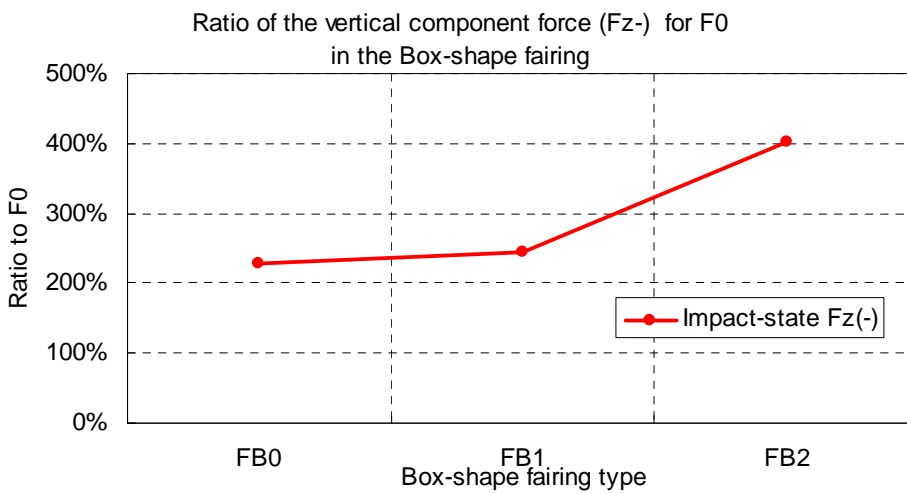

Fig.18 Ratio of the Vertical Component Force ( $F_{z-}$ ) for  $F_0$  in the Box-shape Fairing

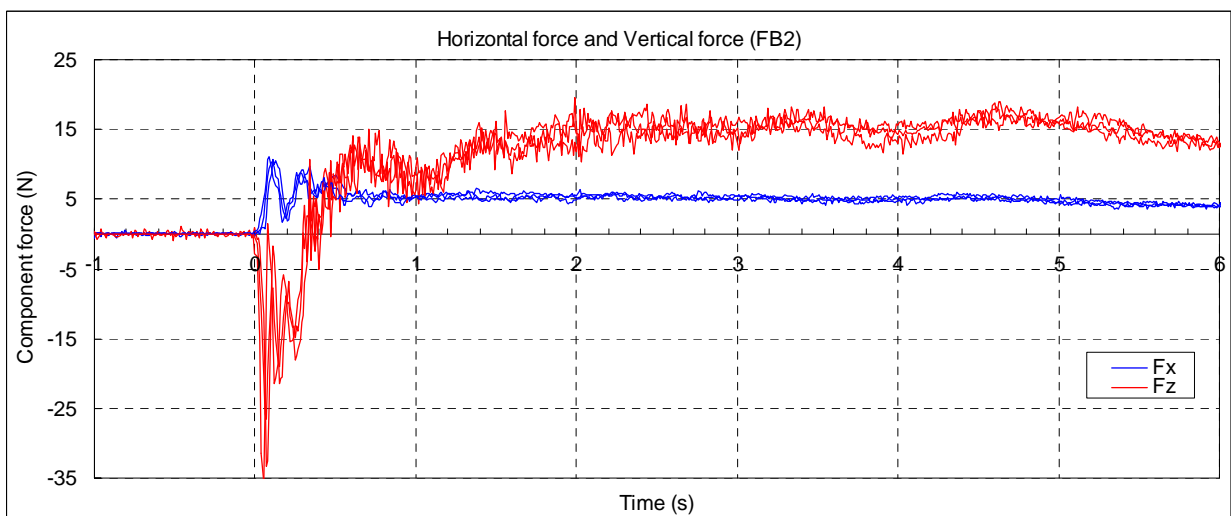
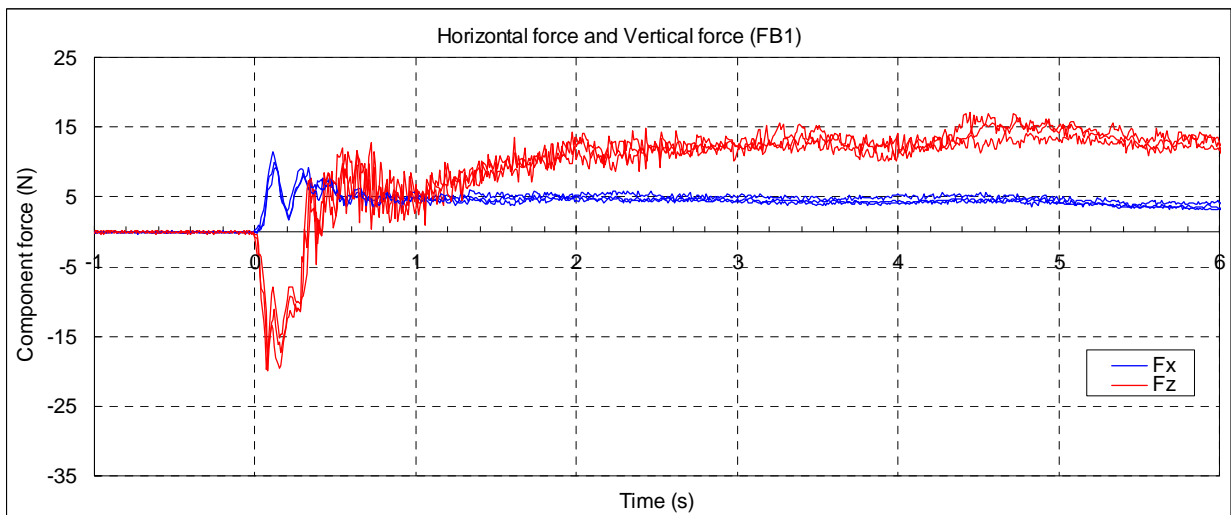
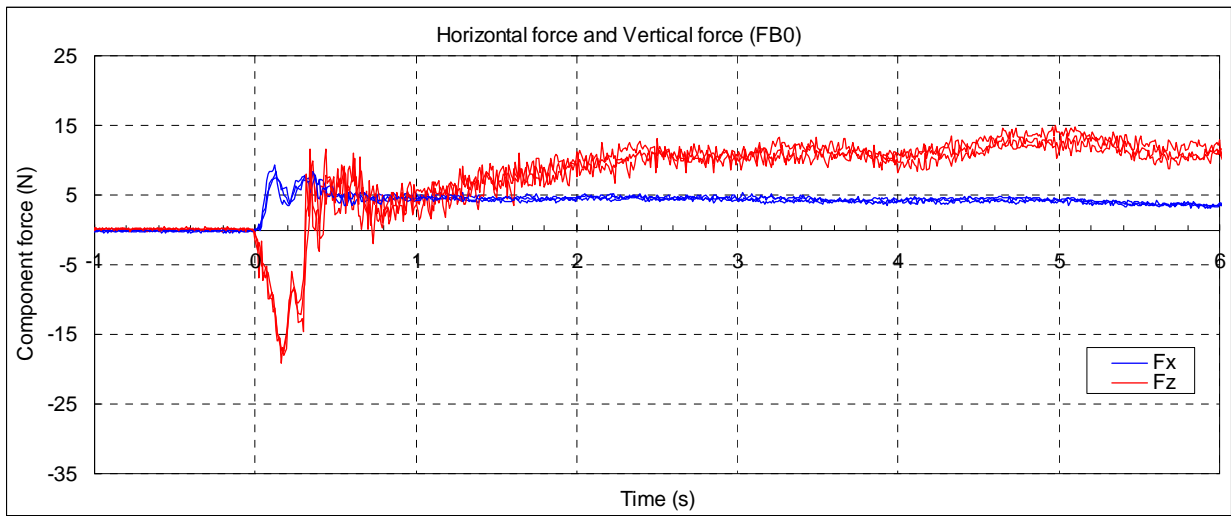

Fig.19 Time-history Waveforms of the Force Component Meter (FB0-FB2)

#### 4. Conclusion

The experiment was carried out using a model of 1/50 scale of Kesen-Bridge which was damaged by the tsunami in the 2011 off the Pacific coast of Tohoku Earthquake. Purpose of experiments is to verify the effect on the force acting to the bridge by installing Box-shape and L-shape fairing. By considerations on results of experiments, the following conclusions were obtained;

1) By installing the L-shape fairing, it was possible to reduce 60-90% horizontal component force ( $F_x$ ) at impact-state, as compared with the case of not installed. And in the steady-state, it was possible to reduce about 70% for vertical component force ( $F_z$ ) in F3 and F4, by installing L-shape fairing. Therefore, it was found that it is possible to reduce component force of both horizontal and vertical, in F4 and F3.

2) Box-shape fairing was possible to significantly reduce the horizontal component force. However, the vertical component force is increased greatly due to the influence of buoyancy. Therefore, it is necessary to solve the problem of buoyancy.

Future task is to examine the fairing shape that can be reduced buoyancy. In addition, experiments on the Influence of the fairing angle are planned for reference data to design.

#### 5. Acknowledgment

We would like to express our appreciation to Tohoku Regional Bureau Ministry of Land , Infrastructure and Transport which provided us with the information on Kesen-Bridge, and Tohoku Construction Association ( now, Tohoku Regional Development Association ) which provided us with the financial support, and Hachinohe Institute of Technology graduates who supported the experiment.

#### REFERENCES

- Shinichi Nii, Kenji Kosa, Gaku Shoji, and Kichiro Kimura, (2009), "Experimental examination concerning tidal wave action power to bridge" J. of Structural Engineering, Vo.1(55A), 471-482.
- Guangfeng ZHANG, Toshihiro USUI, and Jun-ichi HOSHIKUMA, (2010), "Experimental study on a countermeasure for reducing tsunami wave force acting on superstructure of bridges", J. of Structural Engineering, 66(1), 425-433.
- Kenji KOSA, Satoshi UCHIDA, Shigeki UNJHO, Gaku SHOJI, (2007), "INVESTIGATION AND ANALYSIS OF THE DAMAGED BRIDGES DUE TO THE SUMATRA" J. of Earthquake Engineering, Vol.29, 895-901.
- Yulong ZHENG, Kenji KOSA, Li FU, (2013), "EVALUATION FOR OUTFLOW OF GIRDER DUE TO TSUNAMI", JSCE Annual Meeting, I-029, 57-58